



CFP

FILLING VALVES

SERIES 10

SANDWICH MOUNTING

p max **350** bar

Q max (see table of performances)

OPERATING PRINCIPLE

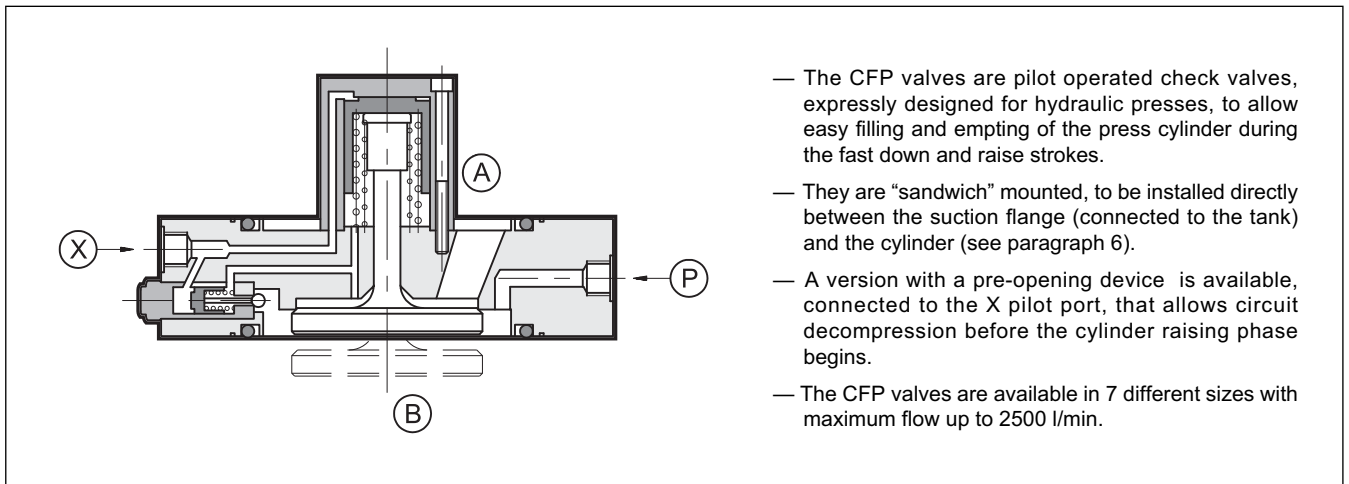

PERFORMANCES

VALVE CODE		CFP-S032	CFP-S040	CFP-S050	CFP-S063	CFP-S080	CFP-S100	CFP-S125
Nominal size		DN-32	DN-40	DN-50	DN-63	DN-80	DN-100	DN-125
Maximum flow (with $\Delta p = 0,3$ bar and viscosity 36 cSt)	l/min	160	250	400	600	1000	1600	2500
Maximum pressure	Ports P and B	bar						
	Port X	bar						
	Port A	bar						
Cracking and pilot pressure		see paragraph 4						
Mass	kg	1,2	1,7	2,5	3,5	5,2	12	20

Ambient temperature range	°C	-20 / +50
Fluid temperature range	°C	-20 / +80
Fluid viscosity range	cSt	10 ÷ 400
Recommended viscosity	cSt	25
Fluid contamination degree	according to ISO 4406:1999 class 20/18/15	

HYDRAULIC SYMBOL

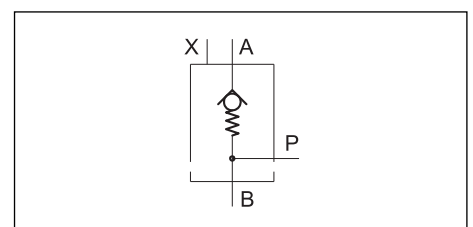

1 - IDENTIFICATION CODE

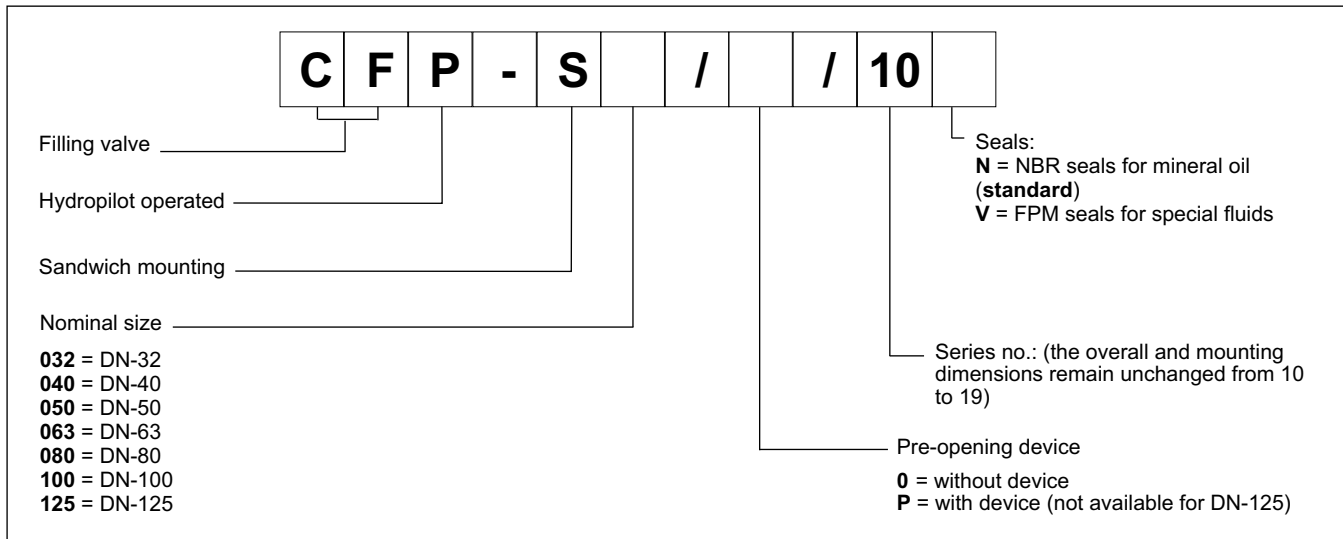

2 - CHARACTERISTIC CURVES

(values measured with viscosity of 36 cSt at 50°C)

Δp - Q characteristic with flow A → B.

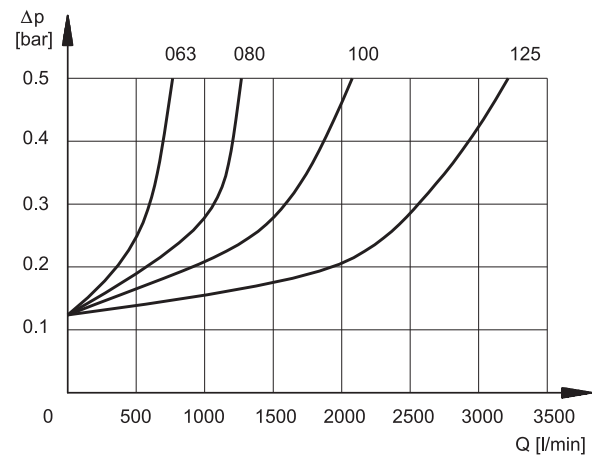
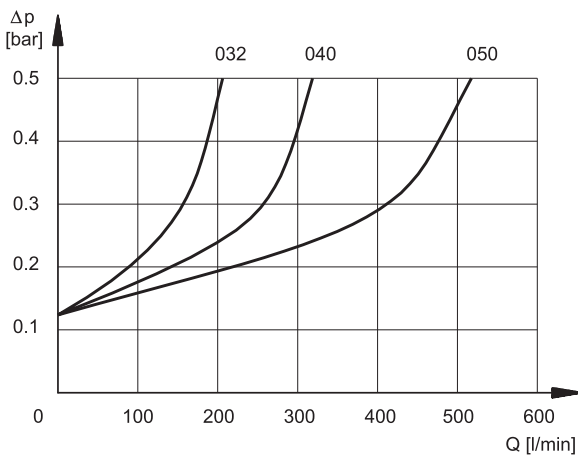

3 - HYDRAULIC FLUIDS

Use mineral oil-based hydraulic fluids HL or HM type, according to ISO 6743-4. For these fluids, use NBR seals. For fluids HFDR type (phosphate esters) use FPM seals (code V). For the use of other kinds of fluid such as HFA, HFB, HFC, please consult our technical department. Using fluids at temperatures higher than 80 °C causes a faster degradation of the fluid and of the seals characteristics.

The fluid must be preserved in its physical and chemical characteristics.

4 - OPENING AND PILOTING PRESSURES

Valve code	Cracking pressure A - B [bar]	Minimum pilot pressure [bar]	Pilot pressure ratio p (B) / p (X)	Pre-opening pressure (option /P) [bar]	Pilot volume for opening valve [cm ³]
CFP-S032	0,12	8,0	3,6	$p(X) = 0,18 \times p(B) + 7$	1,22
CFP-S040			3,9		2,36
CFP-S050			4,2		4,91
CFP-S063	0,13		4,2		8,13
CFP-S080			4,5		12,72
CFP-S100			4,3		28,63
CFP-S125			4,3	67,86	
			-		

5 - INSTALLATION

The valves up to size 63 can be mounted in any position. For the larger sizes (ND 80, ND 100 and ND 125) is required the vertical mounting.

6 - OVERALL DIMENSIONS

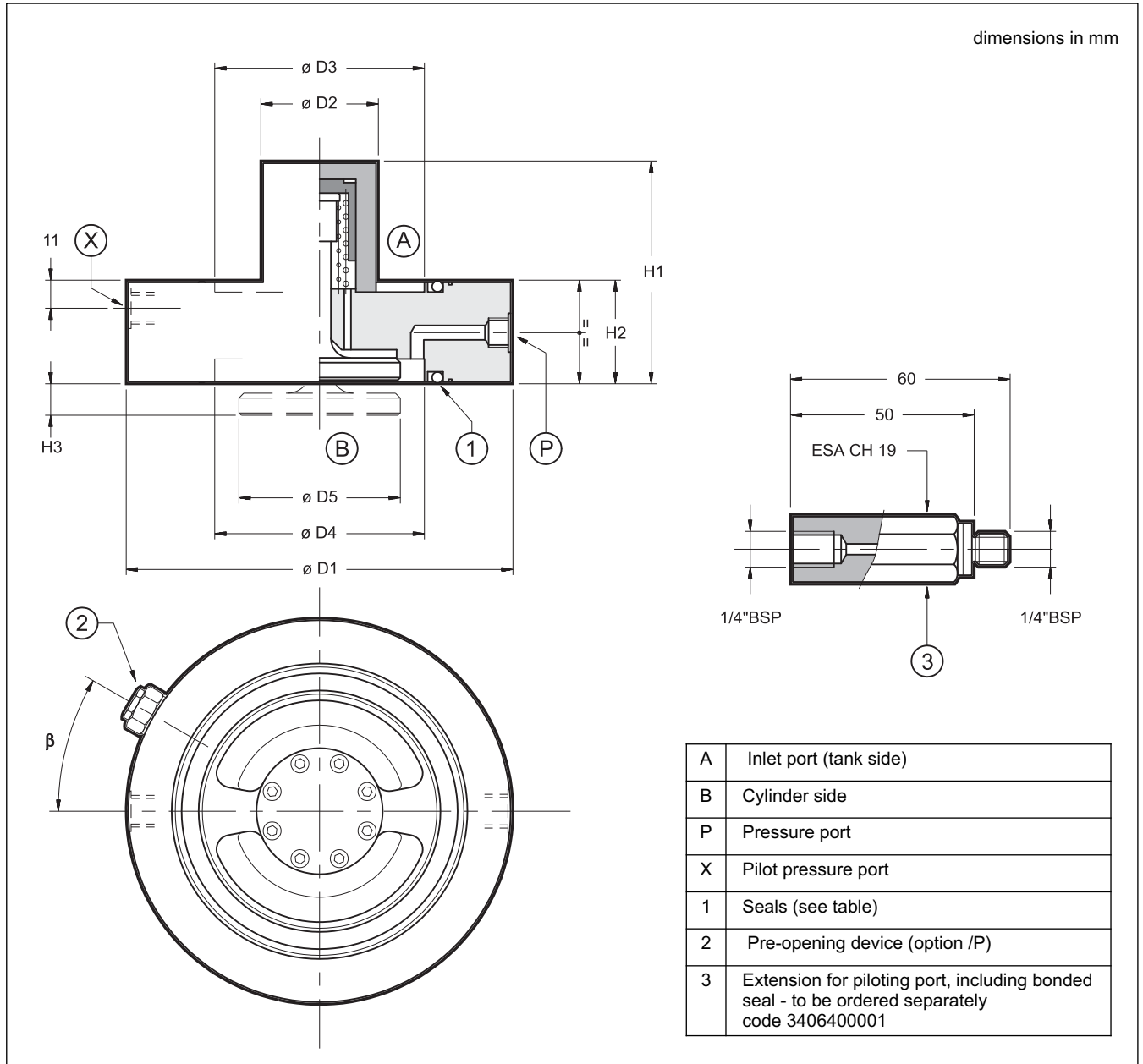

	D1 [mm]	D2 [mm]	D3 [mm]	D4 [mm]	D5 [mm]	H1 [mm]	H2 [mm]	H3 [mm]	B	P	X	1 KANTSEAL
CFP-S032	93	32	43	43	32	55	27	8,2	60°	1/4" BSP	1/4" BSP	DKAR00227 (53.57x3.40x3.40)
CFP-S040	108	39	58	58	41,5	60	28	8,9	45°			DKAR00231 (66.27x3.40x3.40)
CFP-S050	128	45	73	73	53	72	29	12,9	45°			DKAR00236 (82.14x3.40x3.40)
CFP-S063	143	50	87	87	63	83	34	13,4	45°			DKAR00343 (94.62x5.16x5.16)
CFP-S080	169	56	107	107	80	98	38,5	17,8	45°			DKAR00350 (116.84x5.16x5.16)
CFP-S100	212	70	130	130	100	118	44	23,4	45°			DKAR00433 (139.07x6.73x6.73)
CFP-S125	248	88	151	168	127	154	51	27,4	-	3/8" BSP	DKAR00442 (183.52x6.73x6.73)	

7 - CONNECTION FLANGE - INSTALLATION AND DIMENSIONS

dimensions in mm

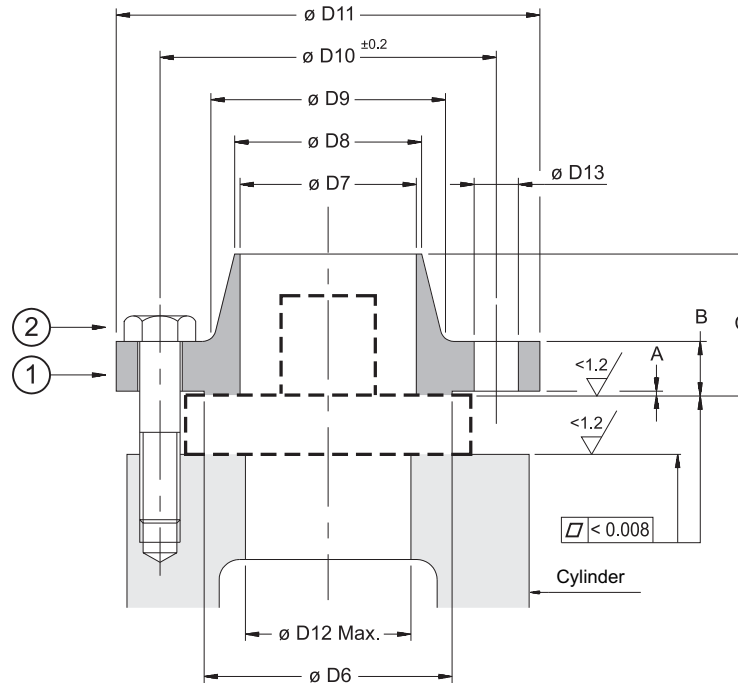

Recommended building material: C22

	(1) Suggested dimensions for connection flange (see NOTE 2)											Max pressure on port B [bar]	(2)		
	D6 [mm]	D7 [mm]	D8 [mm] NOTE 1	D9 [mm]	D10 [mm]	D11 [mm]	D12 [mm]	D13 [mm]	A [mm]	B [mm]	C [mm]		Fastening bolts (type A10.9)	Q.ty	Tightening torque [Nm]
CFP-S032	88	42	48,3	88	110	150	46	18	3	22	45	350	M16	4	285
CFP-S040	102	53	60,3	102	125	165	58	18	3	29	62		M16	4	285
CFP-S050	122	69	76,1	122	145	185	71	18	3	34	68		M16	8	285
CFP-S063	138	82	88,9	138	160	200	86	18	3	43	72		M16	8	285
CFP-S080	162	107	114,3	162	190	235	108	22	3	51	78		M20	8	560
CFP-S100	188	131	139,7	188	240	295	132	29	3	62	105		M27	8	1400
CFP-S125	218	160	168,3	218	280	345	170	32	3	79	115		M30	8	1900

NOTE 1: Calculated diameters for PN 16 - DIN 2448 steel pipes

NOTE 2: For application with standard connection flange type UNI2284 - UNI2285 - UNI2286, special bushings to fit on fastening bolts must be provided in order to ensure a correct valve mounting.

For information about the installation with UNI connector flange, please consult our technical department.