

HYDAC

INTERNATIONAL

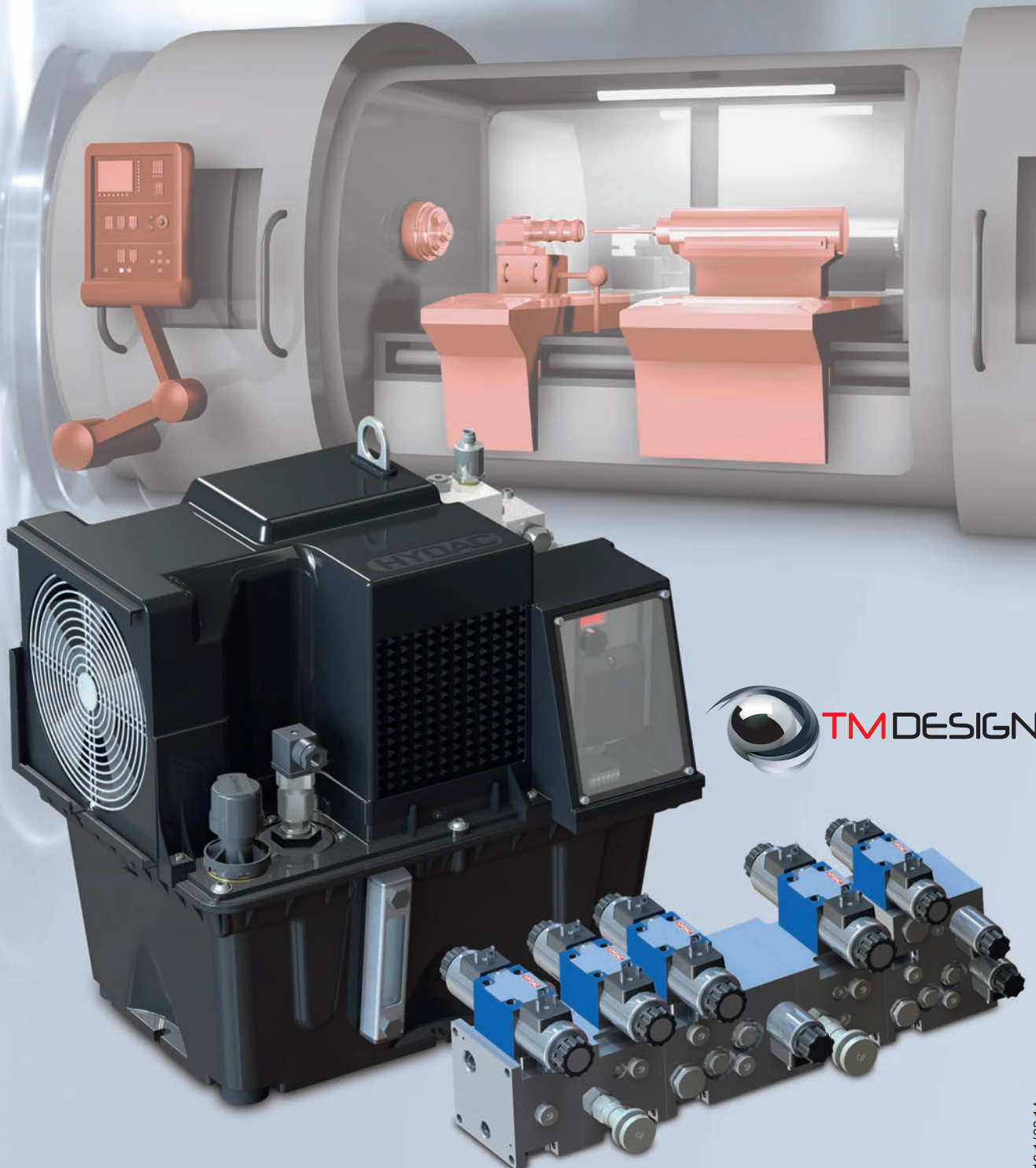

The Innovative HYDAC Solution for Lathes: Compact Power Unit C03, Frequency Controlled, and Manifold Stacking System HL



Your Partner for Expertise in Hydraulic Solutions in Lathes

Intelligence for lathes

The frequency-controlled Compact Power Unit CO3, together with the intelligent control logic of the Manifold Stacking System HL, provides the “smart” hydraulics for your lathe.

The frequency-controlled, continuous-rated double pump of the CO3 reacts to every demand spike and compensates immediately. In addition, efficient air flow in the power unit housing guarantees optimal motor and oil cooling. All in all, this ensures excellent machine availability.

The new Manifold Stacking System HL is a new type of control logic for the auxiliary functions in a lathe.

It is a combination of individual standard modules. Each function module can be used both independently and in combination. The sequence of modules depends on the control task, as does the use of pressure, flow control, shut-off and directional control valves on the module.

The system can easily be customized as extending and replacing is very simple.

If the application requires it, the power unit and manifold stack can be used completely independently.

Compact unit CO3

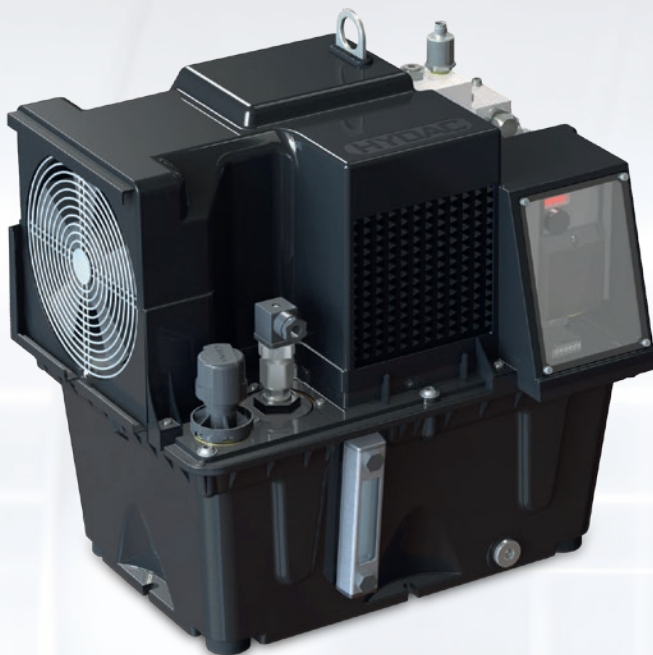

Energy efficient

Suitable for continuous operation

Quiet running (optional)

Plug & Play

Reliable

High degree of integration

Manifold stacking system HL

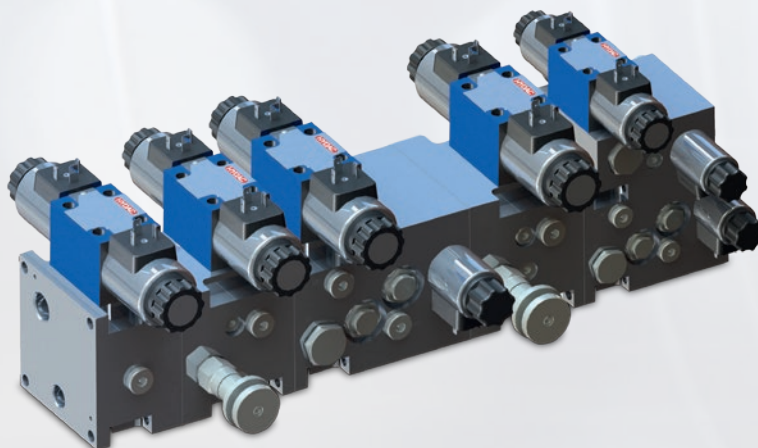

Plug & Play

Reliable

Energy efficient

High degree of integration

System Solutions for each Specific Requirement



Frequency-controlled
Compact Power Unit CO3 –
designed for continuous
operation at constant load



Modules of the Manifold Stacking System HL

Flow optimized, flexible and
extendable control module,
developed with the aim of being
able to service all the hydraulic
functions required in a machine
tool in a compact design.



The main functions of the
module are equipped with
CETOP-valves and can be
used in a stacking system or
as individual function blocks.

There are different basic
controls which can be equipped
differently, depending on the
application.

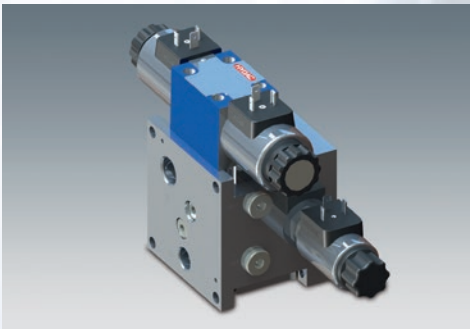

The individual modules have
a carry-over pressure
and tank line with threaded
connection on both sides.
 $P = 2x G3/8''$; $T = 2x G1/2''$

Benefits:

- Compact design because just one Cetop valve is required, compared to the conventional manifold block solution; all the other valves are built into the housing in cartridge form
- The result is less expense for pipework, less material and less installation time
- Flexibility – the block can be connected on both sides
- If further functions required, can easily be extended
- For some modules, just one pressure gauge required per module

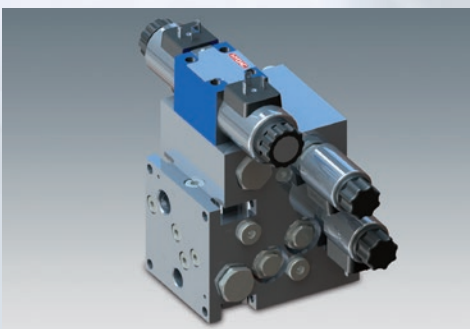

Modular Solutions for Maximum Operating Safety in Continuous Duty S1

Supply, cooling, oil conditioning

- Precise, demand-based control and low energy consumption due to frequency-controlled motor
- Reduced oil volume required in the whole circuit owing to demand-based supply
- Lower cooling capacity required due to lower power loss than on conventional power units
- Optimum pressure supply thanks to demand-based pressure reduction at every operating point
- Optimum motor and oil cooling due to efficient air flow in the power unit housing with fully integrated cooler
- Designed for continuous duty S1
- Very efficient cooling with low energy requirement
- Constant oil cooling and conditioning due to double pump
- Completely enclosed in a housing made of fibre-reinforced composite material and low-frequency stand-by operation means the power unit is barely noticeable.
- Quiet running pump optional
- Simple and time-saving commissioning due to pre-defined electrical and hydraulic connections
- International connections
- Components have been service-life tested, proving themselves over many years, and thus guarantee excellent availability
- Power unit is self-monitored via frequency transmitter: motor, oil temperature and overload
- **TM-Design** (Tuned Monolithic Design) and the consistent use of modern materials in the composite ensures low weight and a very high power density

Control logic for auxiliary functions

- Can be used as an individual module or in stacking configuration locally in the machine
- Installed close to the particular machine
- Can easily be extended to achieve the required range of functions
- Tried-and-tested cartridge valve technology in conjunction with Cetop valves in completely re-designed and Δp -optimized, modular housings
- High energy saving potential due to zero-leakage cartridge poppet valves in conjunction with an accumulator charging function
- A choice of standardised valve cavities combined intelligently in the particular module allows various circuits to be achieved completely within the module

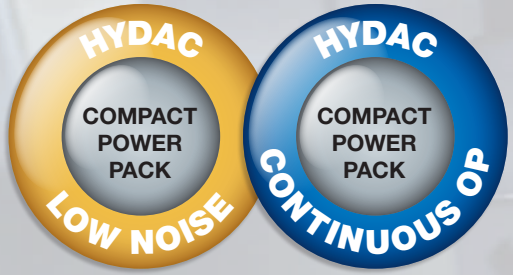

The C03 in detail

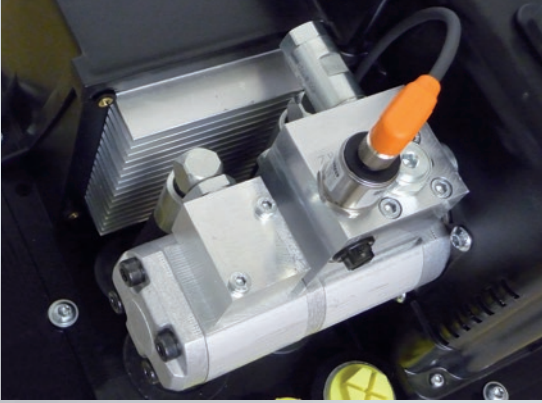

Double pump



Fan with protective grille and optional dust protection filter



Oil/air cooler



Left:
Frequency inverter



Right:
Oil level gauge with optional electrical monitoring

Compact Power Unit CO3 – Constantly in Operation for Maximum Productivity

Designed for continuous duty S1

The Compact Power Units CO3 are constantly in use – literally, because they are designed for continuous operation S1.

For use in lathes, these power units are equipped with a frequency-controlled double pump which enables it to react immediately to every demand spike and to compensate. At the same time, as a result they require lower drive power than conventional power units and in addition handle the oil conditioning and cooling.

Specifications

Frequency inverter

	1 Ph – 1.5 kW	3 Ph – 2.2 kW
Supply voltage:	200 – 240 V	380 – 480 V
Supply frequency:	50/60 Hz	50/60 Hz
Rated current of the device:	7.0 A	5.0 A

Motor-pump unit

Rated power:	1.5 kW	2.2 kW
Maximum speed:	2,520 1/min	2,520 1/min
Permitted flow rate for S1 operation*:	10.0 l/min	7.0 l/min
Max. flow rate:	18+/-0.5 l/min	18+/-0.5 l/min
Operating pressure:	max. 50 bar	max. 70 bar
Pressure relief:	55 bar	75 bar
Pump displacement Vg 1:	7.4 cm ³ /rev	
Pump displacement Vg 2:	6.1 cm ³ /rev	
Axial fan motor output:	50/40 W	
Supply voltage:	220/240 V – 50/60 Hz-1 Ph (on request 200/220 V – 50/60 Hz-1 Ph)	
Duty:	Continuous*	
Tank fill volume	approx. 17 l	
Tank discharge volume:	approx. 10 l	
Operating fluid:	Mineral oil HL/HLP to DIN51524 Part 1 and 2	
Permitted oil temperature:	-20 °C to +80 °C	
Ambient temperature:	-20 °C to max. +35 °C	
Viscosity:	10 mm ² /s to max. 380 mm ² /s (200 mm ² /s recommended)	
Filtration:	To ISO 4406 class 21/19/16 or cleaner	
Protection class:	IP54 to DIN EN 60034-5	
Total weight when empty of oil:	approx. 29 kg	
Total weight when filled with oil:	approx. 46 kg	

The basic power unit includes:

- Fixed pressure relief valve DB
- Check valve
- Oil temperature switch
- Frequency inverter
- Motor temperature switch
- Cable glands PG16/19
- Fluid level gauge FSA
- Pressure transmitter

Specific examples

Part no. 3956305, CO3FULK17-A-18,0-50-1PH+100F55-RV+M2/HDA8-60
Part no. 3956306, CO3FULK17-A-18,0-70-3PH+100F75-RV+M2/HDA8-100

Design and intelligent technology

Of course, it is not enough just to look good – the Compact Power Unit CO3 has a wealth of carefully co-ordinated technical solutions which are the result of dedicated product development for use in lathes.

The special **TM design** (Tuned Monolithic Design) combines modern materials designed to save space or weight with efficient cooling airflow and high-end components.

It all fits together and combines to form an optimal system – a “seamless” solution for you.



Options

- Feet with rubber dampers (vibration-damping)
- Pressure gauge
- Air filter
- Return line filter
- Clogging indicator on return line filter
- Electrical fluid level sensor FSK instead of FSA
- Low-noise pump
- Oil drain hose with ball valve

Circuit diagram

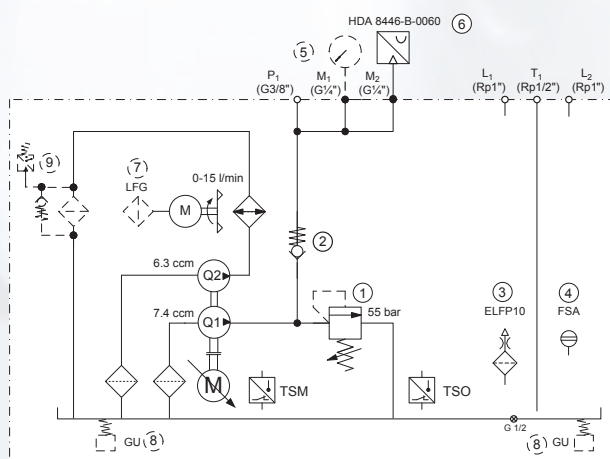

Controlling the Tailstock

HYDAC solution: HL module FD5

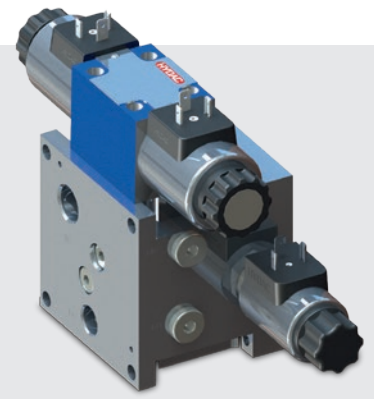
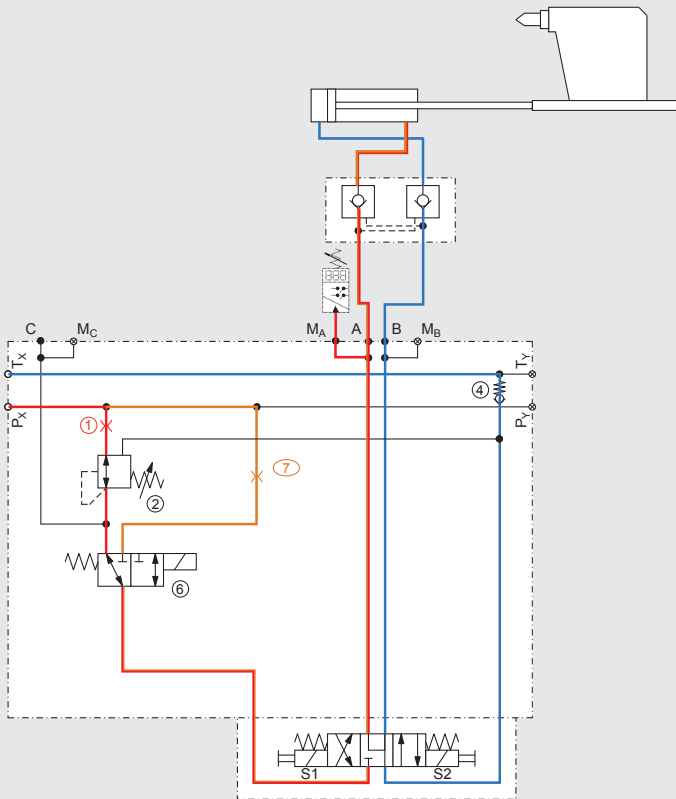

Function

The two speeds required for positioning the tailstock (rapid and slow traverse) are achieved using the FD5 module.

Tailstock forward/reverse (rapid traverse)

On operation of the 3/2-directional control valve, the oil flows using the system pressure through the orifice (item 7) to the 4/3-directional valve. Via the 4/3-directional control valve the tailstock can now be extended or retracted in rapid traverse.

Tailstock forward/reverse (slow traverse)

The required clamping pressure is set on the pressure reducing valve (item 2). The oil flows through the orifice (item 1) and the pressure reducing valve (item 2) to the 3/2-directional valve (item 6), which remains at rest. Via the 4/3-directional valve the tailstock can now be extended or retracted in slow traverse.

As an option a pressure switch (e.g. EDS 3000) can be installed at outlet M_A or M_B to monitor the clamping pressure.

Conventional solution

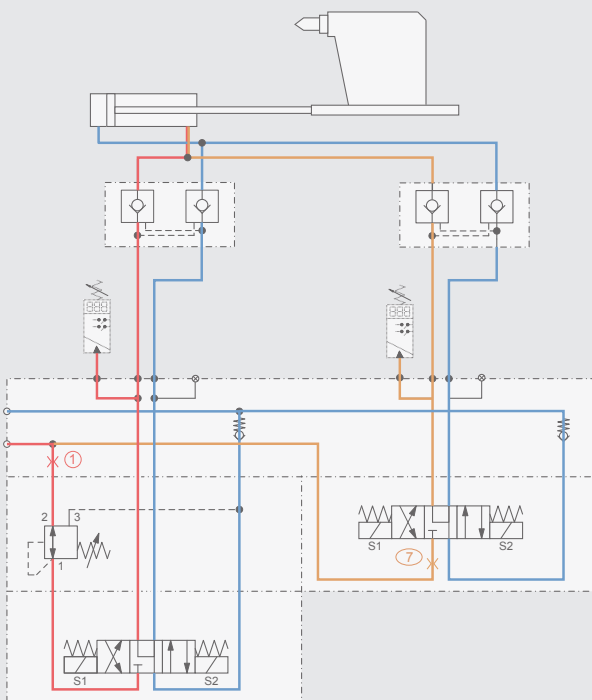

Specifications

Operating pressure:	up to 210 bar
Flow rate:	up to 40 l/min (P) up to 80 l/min (T)
Ports:	$P_X, P_Y,$ $A, B = G\frac{3}{8}$ " $T_X, T_Y = G\frac{1}{2}$ " $M_A, M_B = G\frac{1}{4}$ "

Specific example

Part no. 3940842. HL-FD5-1.0-DR0870H-RV4-WK10C-2.0-0.4WE6J-24DG with orifice item 1 (1.0 mm), with pressure reducing valve item 2 type DR08-70H, with check valve in T line (item 4), with 3/2 directional valve type WK10 (item 6), with orifice item 7 (2.0 mm), with Cetop valve 4WE6J

Controlling the Steady

HYDAC solution: HL module FD2

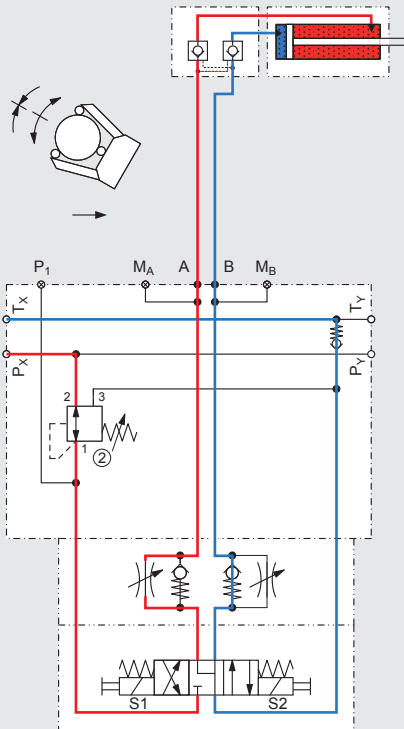

Function

Steady - insertion

The pressure for the steady is set at the pressure reducing valve (item 2). The speeds are set using a speed control valve.

The oil flows through the pressure reducing valve (item 2) to the 4/3-directional valve. The workpiece is supported by the operation of the 4/3-directional valve.

Specifications

Operating pressure:	up to 210 bar
Flow rate:	up to 40 l/min (P) up to 80 l/min (T)
Ports:	$P_X, P_Y,$ $A, B = G\frac{3}{8}"$ $T_X, T_Y = G\frac{1}{2}"$ $M_A, M_B = G\frac{1}{4}"$

Specific example

Part no. 3940862, HL-FD2-0-DR0870H-0-RV4_ZWSDR06-AAB_4WE6J-24DG without orifice item 1, with pressure reducing valve item 2 type DR08-70H, with check valve in T line (item 4), with speed control valve as sandwich plate, with Cetop valve 4WE6J

Conventional solution

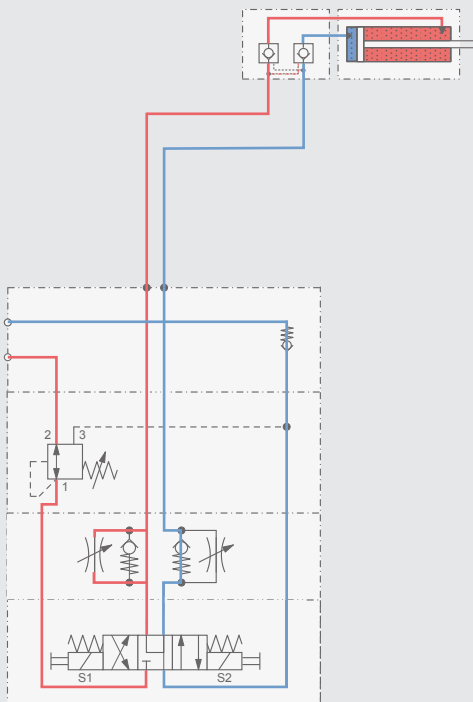

Clamping the Workpiece without and ...

HYDAC solution: HL module FD4

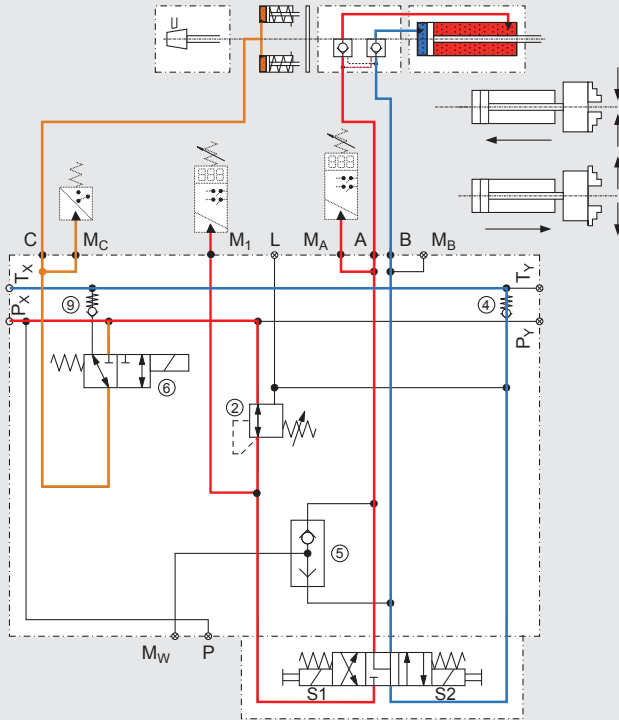

Conventional solution

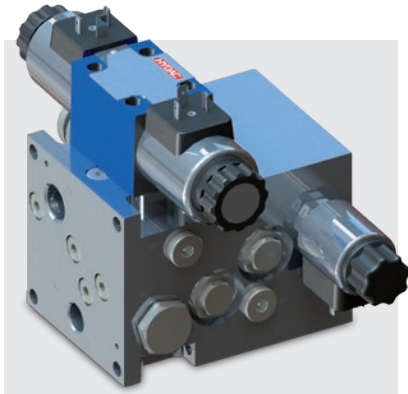
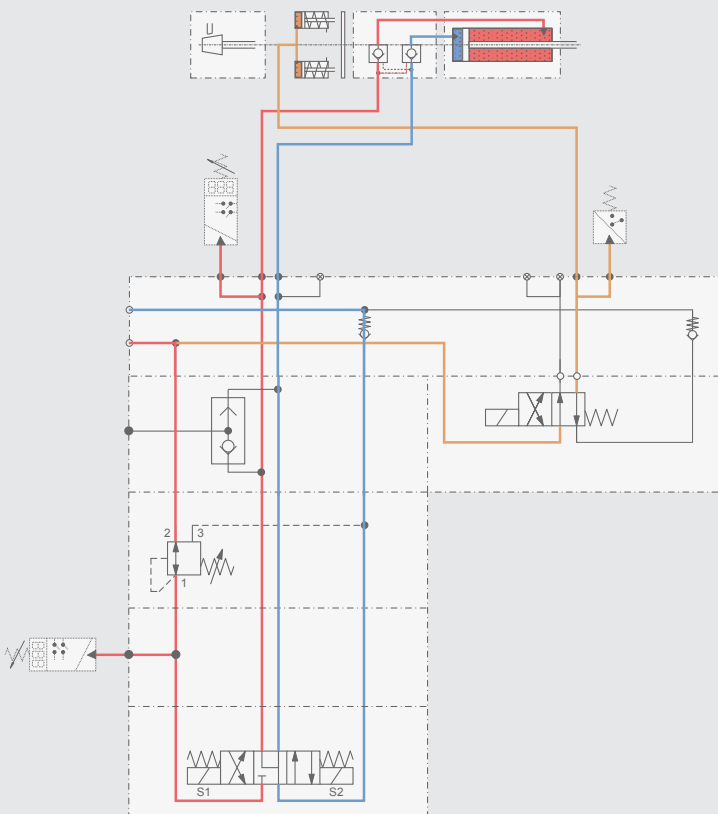

Function

The required clamping pressure is set via the pressure reducing valve (item 2). The oil flows through the valve (item 2) to the 4/3-directional control valve.

The workpiece is clamped by the operation of the 4/3-directional valve.

Braking

The spindle brake is operated by the switched 3/2-directional valve (item 6). As an option, for internal and external clamping, a pressure switch can be installed to monitor the clamping pressure. Since a shuttle valve is also installed, this is only possible using a pressure switch if the test point M_W is used for this.

Specifications

Operating pressure: up to 210 bar
 Flow rate: up to 40 l/min (P)
 up to 80 l/min (T)

Ports: $P_X, P_Y,$
 $A, B = G\frac{3}{8}$
 $T_X, T_Y = G\frac{1}{2}$
 $M_A, M_B,$
 $M_C, M_1,$
 $L = G\frac{1}{4}$

Specific example

Part no. 3940915. HL-FD4-0-DR0870H-0-RV4-WVE-WK08C-0-G8-RV9-G10_4WE6J-24DG, without orifice item 1, with pressure reducing valve item 2 type DR08-70H, with check valve in T line (item 4), with shuttle valve (item 5), with 2/2 directional control valve type WK08C (item 6), with check valve item 9, with Cetop valve 4WE6J

with Differential Pressure

HYDAC solution: HL module FD4 with ZWP1

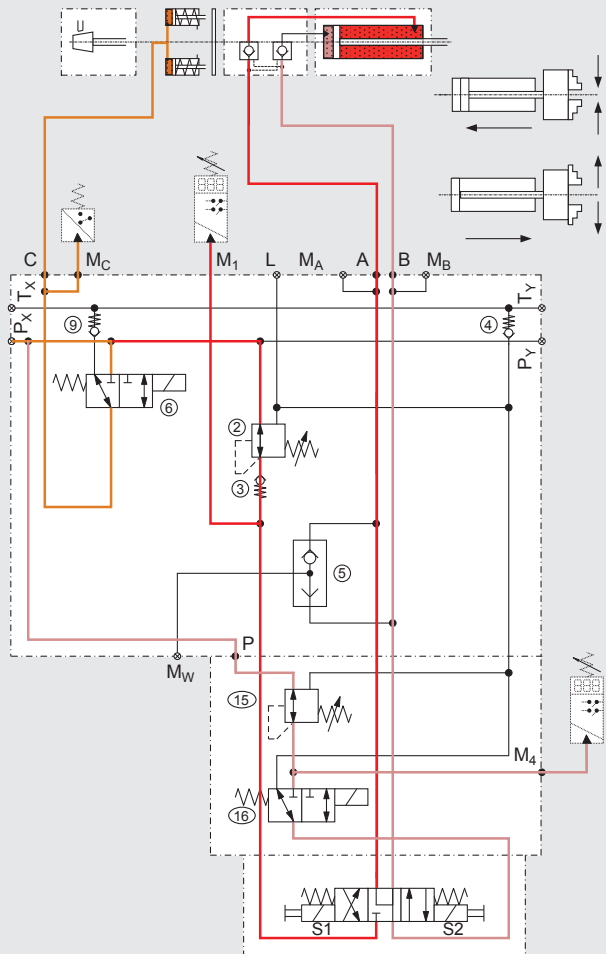

Conventional solution

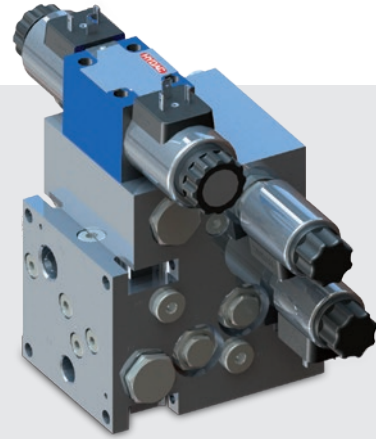
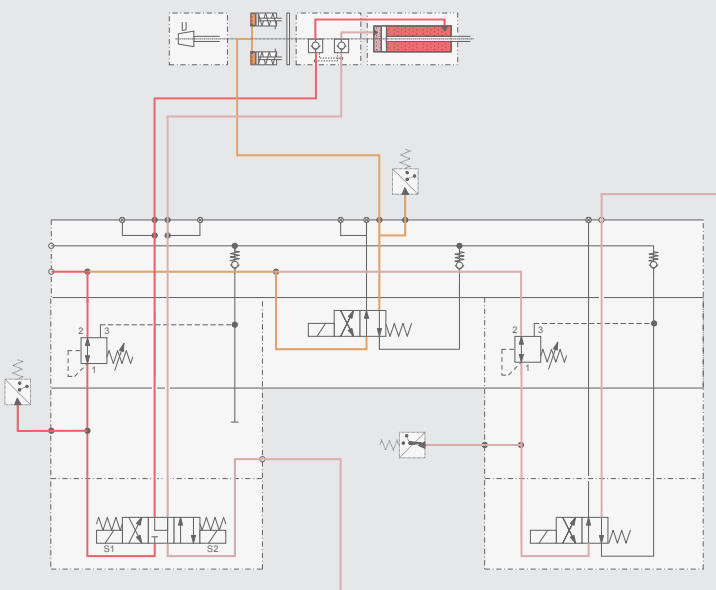

Function

When processing thin-walled material, a clamping pressure below 10 bar is usually required. To achieve this, the main clamping pressure (D1) (dark red line) is used to counteract the counter clamping pressure (D2) (bright red line) (clamping with differential pressure D1-D2). To achieve the counter pressure, it is recommended that the sandwich plate ZWP1 is used in preference.

Clamping the workpiece

The **main clamping pressure D1** is set via the pressure reducing valve (item 2), the **counter clamping pressure D2** is set via the pressure reducing valve (item 15). The oil flows in parallel through the pressure reducing valves (items 2 + 15). The 3/2 directional control valve (item 16) and the 4/3 directional control valve are operated. The workpiece is clamped via the resulting differential pressure (D1-D2).

Releasing the workpiece

The oil flows through the pressure reducing valve (item 2) to the 4/3-directional control valve. The 3/2-directional control valve (item 16) remains in the normal position. By actuating the 4/3-directional control valve the workpiece is released.

Braking

For function description, see page 10.

Specifications

Operating pressure:	up to 210 bar
Flow rate:	up to 40 l/min (P) up to 80 l/min (T)
Ports:	P _X , P _Y , A, B = G 3/8" T _X , T _Y = G 1/2" M _A , M _B = G 1/4"

Specific example

Part no. **3940924**, HL-FD4-0-DR0870H-0-RV4-WVE-WK08C-0-G8-RV9-G10+HL-ZWP1-DR08-WK10C-G17_4WE6J-24DG with pressure reducing valve item 15 type DR08-70H, with 3/2 directional control valve item 16; in addition to module FD4, module ZWP1 is also used.

Turret Control ...

Lubrication ...

HYDAC solution: HL module F0

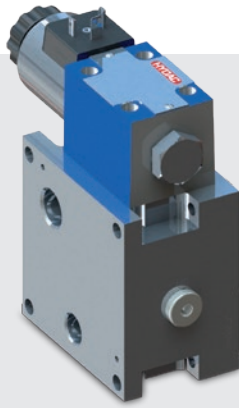
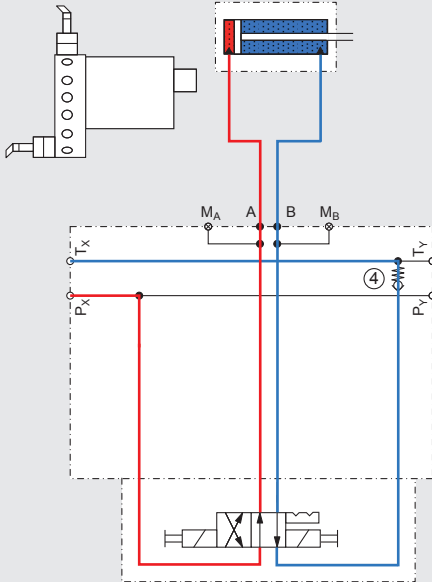

Function

The oil flows under system pressure to the 4/2-directional control valve.

The 4/2-directional control valve operates the indexing function of the turret.

Specifications

Operating pressure:	up to 210 bar
Flow rate:	up to 40 l/min (P) up to 80 l/min (T)
Ports:	P _X , P _Y , A, B = G 3/8" T _X , T _Y = G 1/2" M _A , M _B = G 1/4"

Specific example

Part no. 3940947,
HL-F0-0-RV4_4WE6D-OF-24DG
with check valve in T line (item 4),
with Cetop valve 4WE6D-OF

Conventional solution

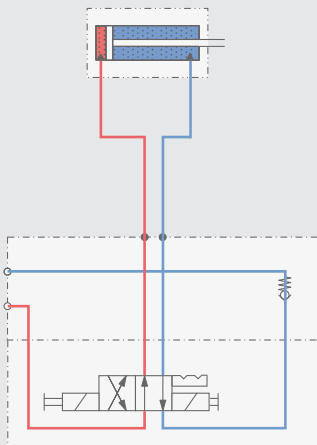

HYDAC solution: HL module F0

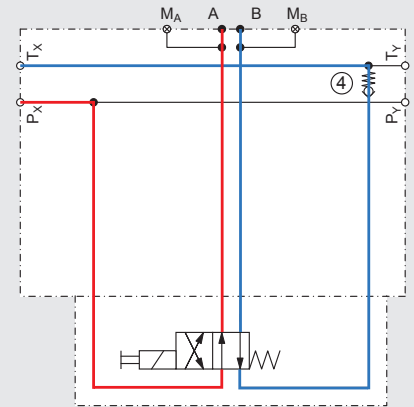

Conventional solution

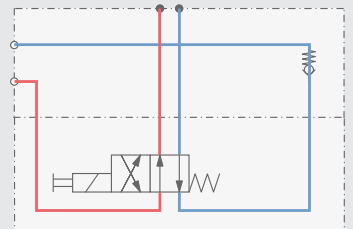

Parts Gripper

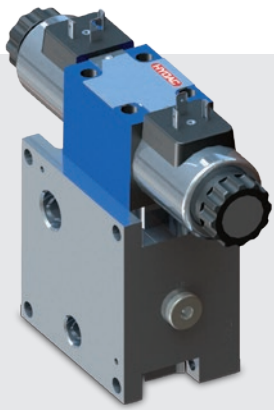

Function

The oil flows under system pressure to the 4/2-directional control valve.

Energising the 4/2 directional control valve supplies the required lubrication point.

Specifications

Operating pressure:	up to 210 bar
Flow rate:	up to 40 l/min (P) up to 80 l/min (T)
Ports:	$P_X, P_Y,$ $A, B = G\frac{3}{8}$ " $T_X, T_Y = G\frac{1}{2}$ " $M_A, M_B = G\frac{1}{4}$ "

Specific example

Part no. 3940950, HL-F0-0-RV4_4WE6D-24DG without orifice item 1, with check valve in T line (item 4), with Cetop valve 4WE6D

HYDAC solution: HL module FD2

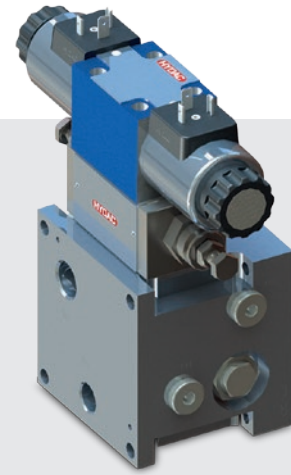
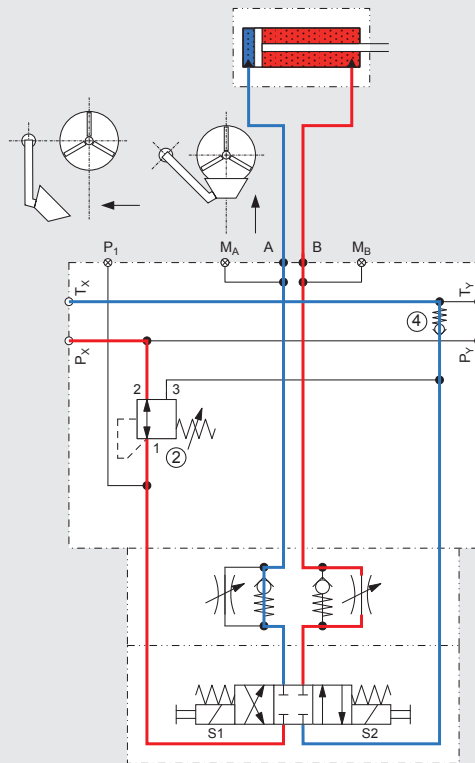

Function

The finished workpiece can be gripped and subsequently unloaded onto the parts conveyor by operating part grippers, an optional feature in a machine tool.

The pressure is set at the pressure reducing valve (item 2). The speeds are set using a speed control valve.

The oil flows through the pressure reducing valve (item 2) to the 4/3-directional valve. By actuating the 4/3-directional control valve, the parts gripper is extended or retracted.

Conventional solution

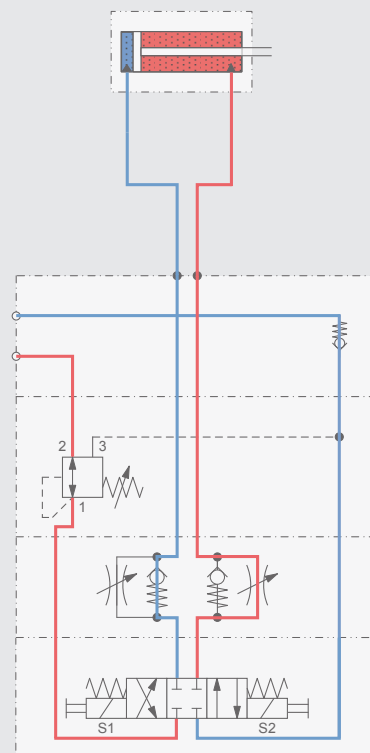

Specifications

Operating pressure:	up to 210 bar
Flow rate:	up to 40 l/min (P) up to 80 l/min (T)
Ports:	$P_X, P_Y,$ $A, B = G\frac{3}{8}$ " $T_X, T_Y = G\frac{1}{2}$ " $M_A, M_B = G\frac{1}{4}$ "

Specific example

Part no. 3940878, HL-FD2-0-DR0870H-0-RV4_ZWSDR06-AAB_4WE6E-24DG without orifice item 1, with pressure reducing valve item 2 type DR08-70H, with Cetop valve 4WE6E



Accumulator Technology 30,000

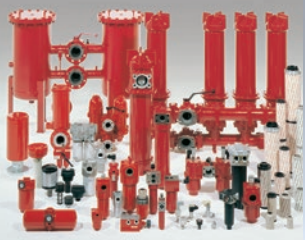

Filter Technology 70,000



Process technology 77,000



Fluid service 79,000



Compact Hydraulics 53,000



Accessories 61,000



Electronics 180,000



Cooling Systems 5,700

Global Presence. Local Expertise. www.hydac.com



- HYDAC Headquarters
- HYDAC Companies
- HYDAC Sales and Service Partners



INTERNATIONAL

HYDAC Fluidtechnik GmbH

Justus-von-Liebig-Straße
66280 Sulzbach/Saar
Germany

Tel.: +49 6897 509-01
Fax: +49 6897 509-577

E-mail: flutec@hydac.com
Internet: www.hydac.com