

DXJ3

ELECTRO-HYDRAULIC SERVOVALVE WITH INTEGRATED ELECTRONICS SERIES 10

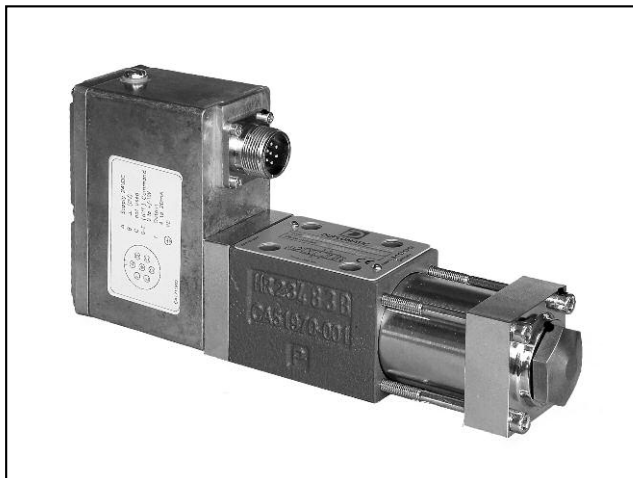

SUBPLATE MOUNTING ISO 4401-03 (CETOP 03)

p max **350** bar
Q max (see performances table)

MOUNTING SURFACE

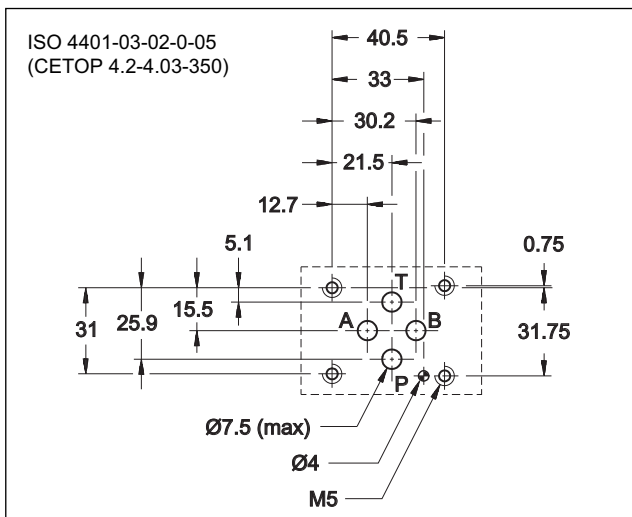

OPERATING PRINCIPLE

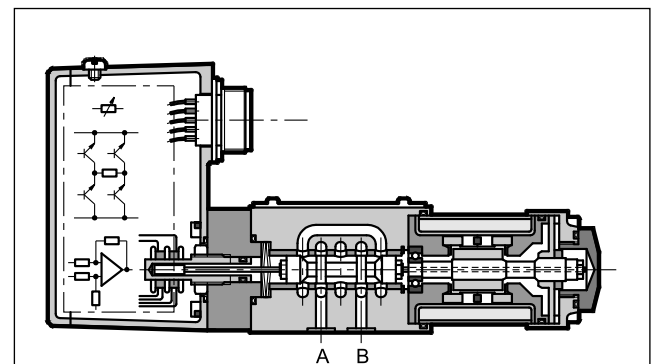

— The DXJ3 valve is a four-way servo-proportional valve where the spool moves inside a sleeve. This valve has a direct drive with a linear force motor resulting in high dynamic performances which are independent of system pressure. The spool position is controlled by a linear transducer (LVDT) with closed loop which ensures high precision and repeatability.

— It is available in four different flow rate control ranges up to 40 l/min, with spools with zero overlap and a mounting surface in compliance with ISO 4401 (CETOP RP 121H) standards.

— The valve is featured by integrated electronic based on SMD technology which ensures standard regulations and simplifies the electric wiring. The unit does not require any adjustment other than the possible electronic regulation of the zero.

— Suitable for control applications with closed loop of position, velocity and pressure. With a loss of power or with a zero reference signal, the spool goes automatically at rest-position. In this position the valve has a minimum leakage, depending on the operating pressure (see the performances table).

PERFORMANCES (with mineral oil of viscosity 36 cSt at 50°C)

Maximum operating pressure Ports P - A - B Port T	bar	350 50
Rated flow Q nom (with Δp 70 bar P - T)	l/min	5 - 10 - 20 - 40
Null leakage flow (with $p = 140$ bar)	l/min	$\leq 3\%$ of Q nom
Hysteresis	% In	$< 0,2$
Threshold	% In	$< 0,1$
Thermal drift (with $\Delta T = 50^\circ C$)	% In	$< 1,5$
Response time	ms	≤ 12
Vibration on the three axes	g	30
Electric features	see paragraph 3	
Protection degree according CEI EN 60529	IP 65	
Ambient temperature range	$^\circ C$	-20 / +60
Fluid temperature range	$^\circ C$	-20 / +80
Fluid viscosity range	cSt	5 + 400
Fluid contamination degree	according to ISO 4406:1999 class 17/15/12 (16/14/11 for longer life)	
Recommended viscosity	cSt	25
Mass	kg	2,5

HYDRAULIC SYMBOL

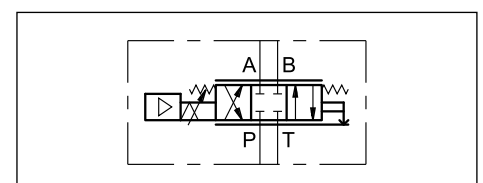

1 - IDENTIFICATION CODE

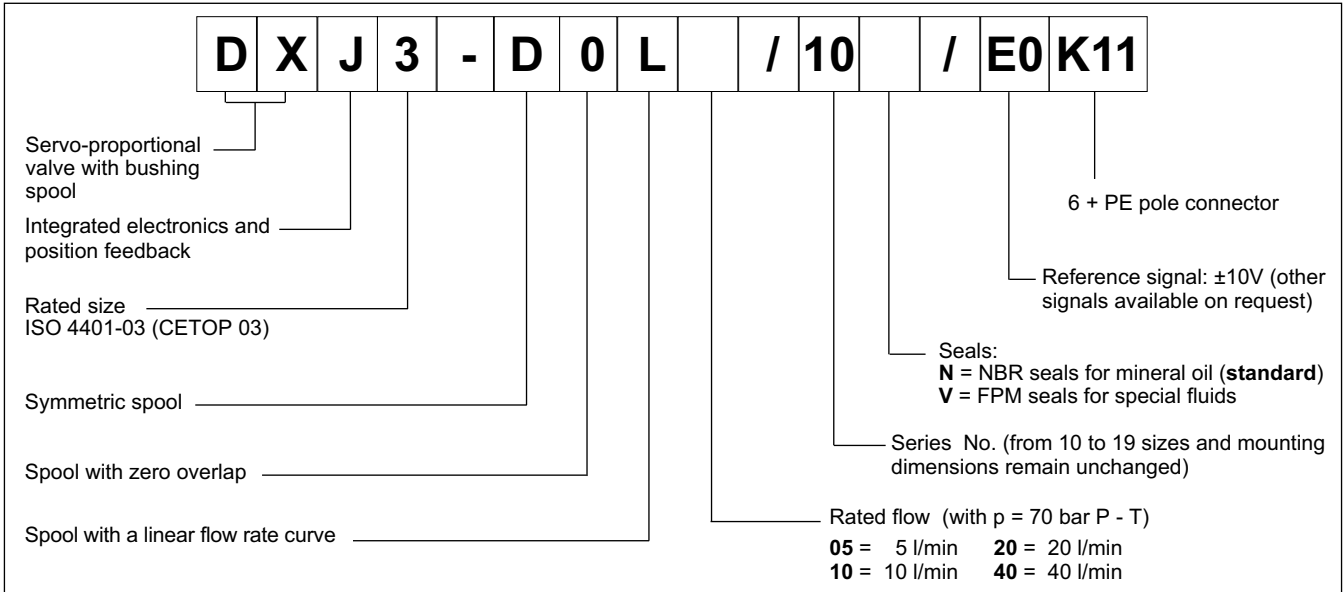

2 - CHARACTERISTIC CURVES (measured with viscosity of 36 cSt at 50°C)

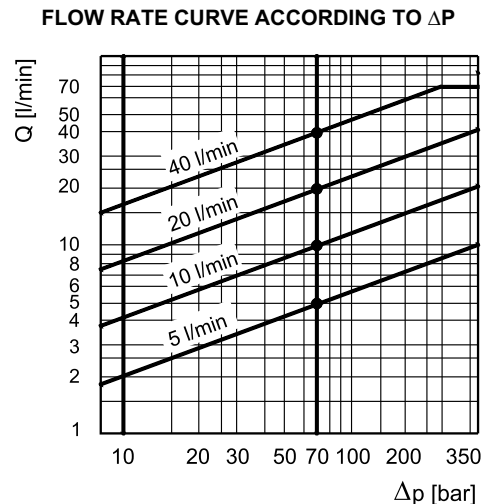
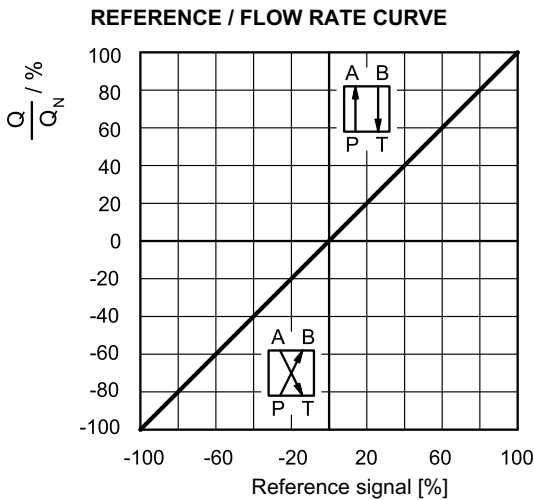

Typical flow rate curves at constant $\Delta p = 70$ bar P-T according to the reference signal.

NOTE: with positive reference signal connected to pin D the valve regulates P - A / B - T.

The diagram states the maximum valve controlled flow rate according to the pressure drop between the P and T ports.

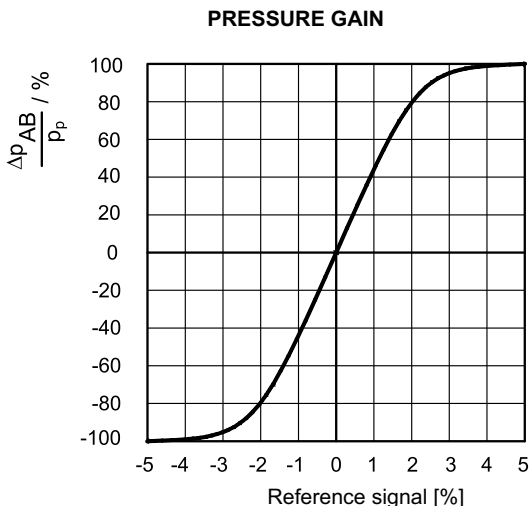

The diagram shows the valve pressure gain, expressed as % of the ratio between the port pressure variation in A or B (Δp_{AB}) and the P system pressure, according to the reference signal. In practice, the pressure gain states the valve reaction towards external disturbances aimed at changing the actuator position.

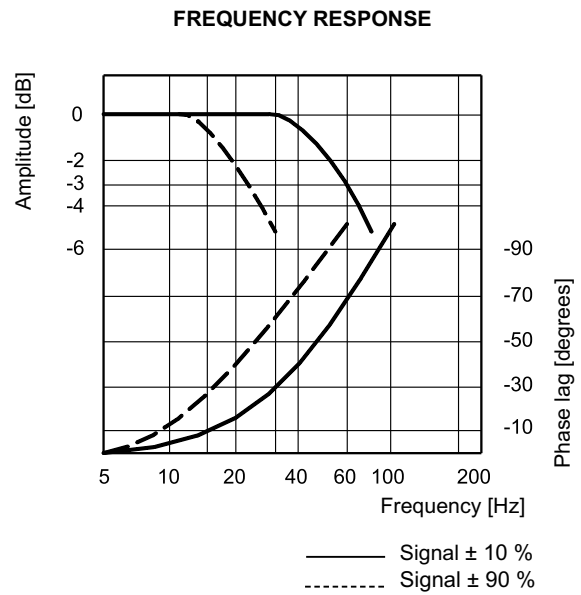
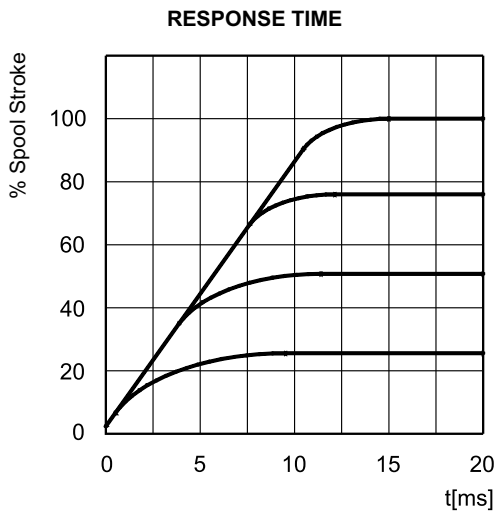

3 - ELECTRICAL FEATURES

CONNECTION WIRING

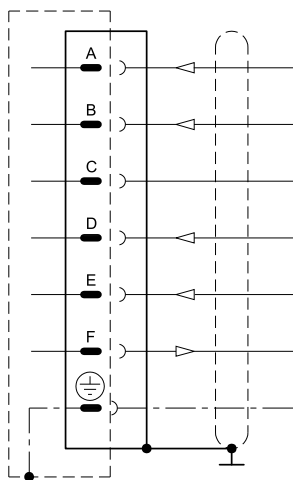

Pin	Values	Function	NOTES
A	24 VDC	Supply	From 19 to 32 VDC $I_{A \text{ MAX}} = 1,2 \text{ A}$
B	0 V	Signal ground	0 V
C	----	Not used	----
D	± 10 V	Input rated command	$R_e = 10 \text{ k}\Omega$ (see NOTE 1)
E	0 V	Input rated command	----
F	4 ÷ 20 mA	Spool position	$R_L = \text{from } 300 \text{ to } 500 \Omega$ (see NOTE 2)
PE	----	Protective earth	----

NOTE 1: The input stage is a differential amplifier. With positive reference signal connected to pin D, valve opening P - A e B - T is achieved. With a zero reference signal the spool is in centred position. The spool stroke is proportional to $U_D - U_E$. If only one command signal is available (single-end), pin E must be connected to pin B (0V ground).

NOTE 2: The spool position value can be measured at pin F (see diagram right). The position signal output goes from 4 to 20 mA. The centered position is at 12 mA, while 20 mA corresponds to 100% valve opening P - A and B - T. This monitoring allows to detect a cable break when $I_F = 0V$.

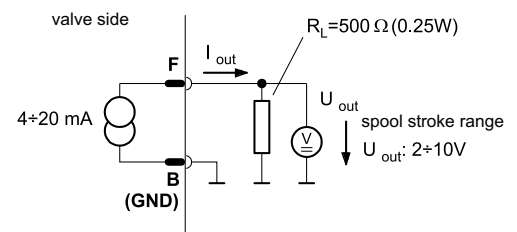

General requirements:

- External fuse = 1,6 A
- Minimum cross-section of all leads $\approx 0,75 \text{ mm}^2$
- When making electric connections to the valve (shield, protective earth) appropriate measures must be taken to ensure that locally different earth potentials do not results in excessive ground currents.
- The differential and the spool position signal lines must be connected to the mating connector housing at valve side and to the 0V (signal ground) at cabinet side.
- **EMC:** meets the requirements of EN 55011:1998, class B, and the immunity regulation according to EN 61000-6-2:1998

4 - HYDRAULIC FLUIDS

Use mineral oil-based hydraulic fluids HL or HM type, according to ISO 6743-4. For these fluids, use NBR seals. For fluids HFDR type (phosphate esters) use FPM seals (code V). For the use of other kinds of fluid such as HFA, HFB, HFC, please consult our technical department. Using fluids at temperatures higher than 80 °C causes a faster degradation of the fluid and of the seals characteristics.

The fluid must be preserved in its physical and chemical characteristics.

5 - INSTALLATION

The DXJ3 valve can be installed in any position without impairing its correct operation.

The valve is fixed by means of screws on a flat surface with planarity between 0,01 mm over 100 mm and roughness $R_a < 0,8 \mu\text{m}$. If the minimum values are not observed, the fluid can easily leak between the valve and the mounting surface. While mounting pay attention to the environment and valve cleanliness.

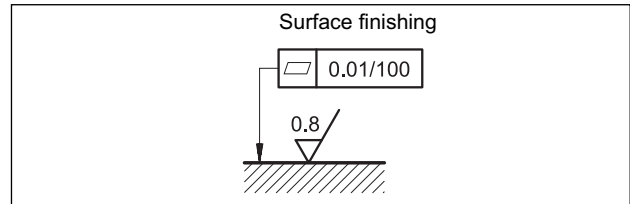

6 - OVERALL AND MOUNTING DIMENSIONS

