



4/3- directional- spool valve

Solenoid-operated, direct acting

4 WE 6 J

SYMBOL

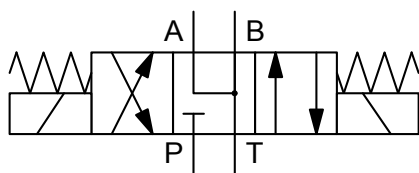

up to 60 l/min
up to 320 bar

FUNCTION

HYDAC 4/3 directional spool valves in the series 4WE 6 J are directional valves for oil- hydraulic systems, which serve to open and close flow paths. In the de-energised mode the control spool is held in the rest position by the return spring. The actuation of the control spool occurs via an oil-immersed solenoid. The solenoid pushes the control spool from its rest position to its final position. This opens the required flow paths according to the symbol. When the solenoid is de-energised, the control spool is pushed back to the rest position by the return spring. A manual override permits the valve to be switched without energizing the solenoid.

FEATURES

- Direct-acting, solenoid-operated valve NW 6
- Economical and reliable due to simple design
- Oil- immersed solenoid armature for long life and low noise operation
- Solenoid coils can be replaced with no possibility of oil leakage
- Interface to DIN 24340 Form A6, ISO 4401
- Manual override

SPECIFICATIONS

| | |
|------------------------------|---|
| Operating pressure: | port A,B,P: p _{max} = 320 bar port T: p _{max} = 210 bar |
| Nominal Flow: | max. 60 l/min |
| Media operating temp. range: | min. -20°C up to max. +80°C |
| Ambient temperature range: | min. -20°C up to max. +55°C |
| Fluids: | hydraulic oil to DIN 51524 part1 and 2 |
| Viscosity range: | 10 mm ² /s up to 500 mm ² /s is recommended |
| Filtration: | Class 20/18/15 according to ISO 4406 or cleaner |
| Max. switching frequency: | 15.000/h |
| MTTF _d : | 150 years |
| Installation: | no orientation restrictions |
| Manual override: | up to approx. 50 bar tank pressure possible |
| Seal materials: | Standard FKM |
| Weight: | 2,0 kg |
| Electrics | |
| Type of voltage: | DC voltage |
| Voltage tolerance: | ±10% |
| Nominal power: | 30W (12V / 2,5A) resp. 32W (24V / 1,33A) |
| Switching time: | Switch-on time (coil): 20 ms up to 70 ms Switch-off time (spring): 10 ms up to 60 ms |
| Coil duty rating: | 100% |
| Electrical connection: | plug to DIN 43650 |
| IP rating: | IP 65 to EN 60529; DIN 40050 provided the connector is fitted correctly |

DIMENSIONS

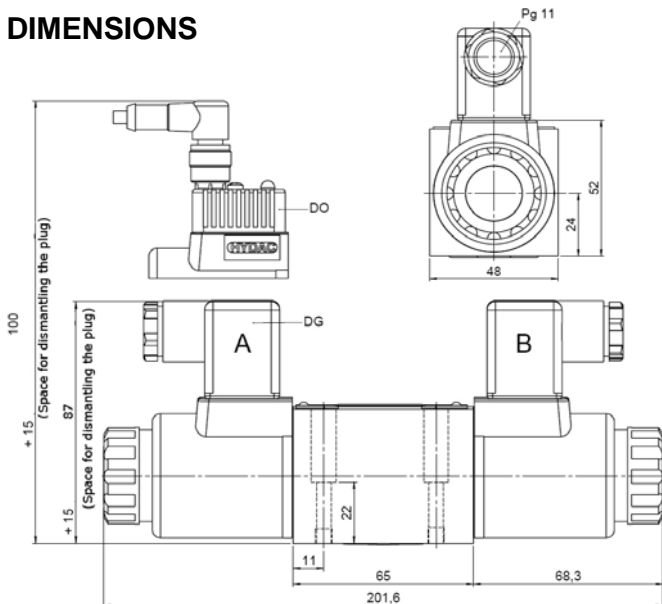

M12 coil Electric wiring

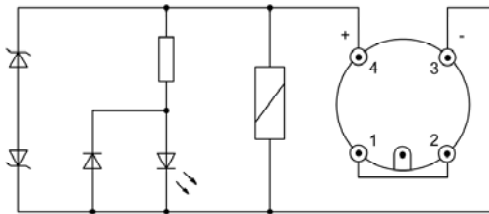

INTERFACE

to DIN 24340-A6 / ISO 4401

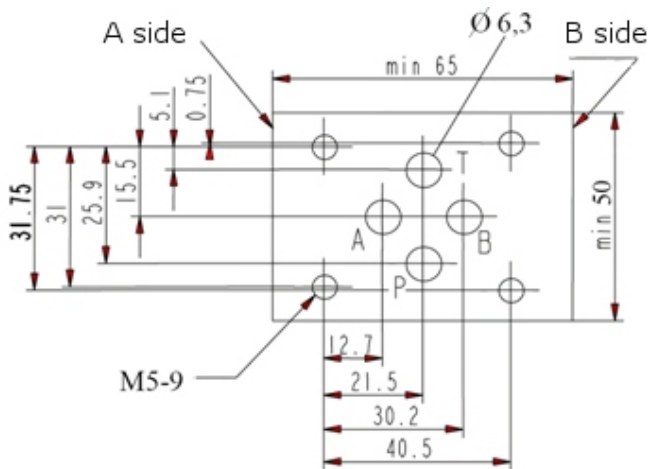

Mounting screws: M5 x 30 DIN 912-10.9

Torque: 6 + 1 Nm

Female connector and mounting screws (4 pcs.) must be ordered separately.

Crossover

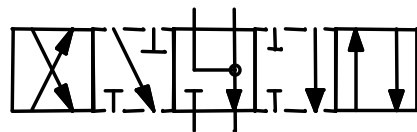

NOTE

The information in this brochure relates to the operating conditions and applications described. For applications or operating conditions not described, please contact the relevant technical department. Subject to technical modifications.

HYDAC Fluidtechnik GmbH
Justus-von-Liebig-Str. 5
66280 Sulzbach / Saar
Tel.: 06897 / 509 -0
Fax: 06897 / 509 -598
Email: flutec@hydac.com

MODEL CODE

Name 4WE 6 J S01 - 12DG / V
4/3-directional spool valve

Nominal size 6
6 = Nominal size 6

Symbol _____

Series _____
Determined by manufacturer

Nominal voltage _____
12 = 12 Volt DC voltage
24 = 24 Volt DC voltage
96 and 205 Volt DC voltage on request (only type DG)
DG: DIN plug to EN 175301-803
DO: M12x1 plug

Seal material _____
V = FKM (Standard)
N = NBR

| Supply voltage +/- 10% | Nominal voltage of the DC-coil | Nominal power of the DC-coil |
|---------------------------|-----------------------------------|---------------------------------|
| 110 V – 50/60 Hz | 96 V | 32 W |
| 230 V – 50/60 Hz | 205 V | 33 W |

by using a female connector with integrated rectifier

Standard models

| Name | Part No. |
|----------------------|----------|
| 4WE 6 J S01-12DG / V | 6063117 |
| 4WE 6 J S01-24DG / V | 6063148 |

other models on request

Pressure drop

Measured at $v = 36 \text{ mm}^2/\text{s}$ and $t_{\text{oil}} = 45^\circ \text{C}$

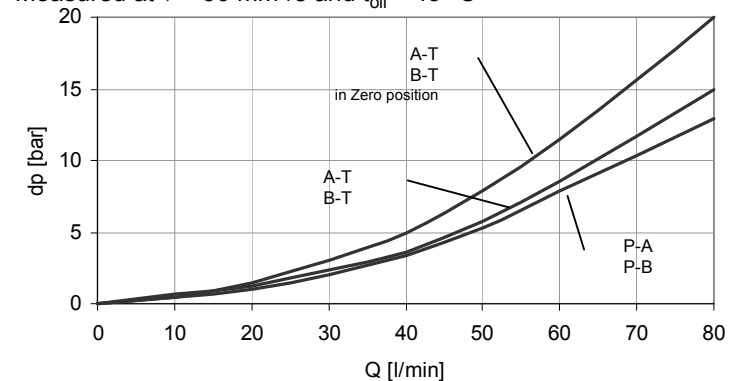

Operating limits

Measured at $v = 36 \text{ mm}^2/\text{s}$ and $t_{\text{oil}} = 45^\circ \text{C}$

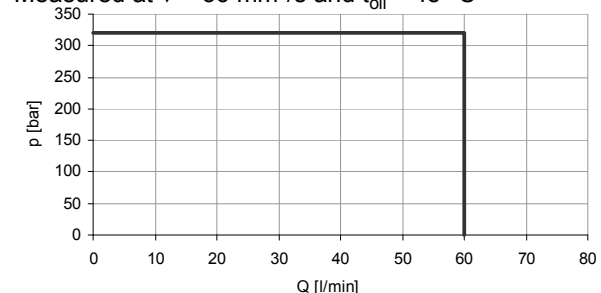

The operating limits were determined using coils at operating temperature and 10% under voltage. The operating limits given are for applications with two flow directions. For flow in only one direction, the operating limits can be lower. For operation with G96/G205 coils max. permitted flow rate shown in the graph must be reduced by 10%. The switch-on times will increase.