

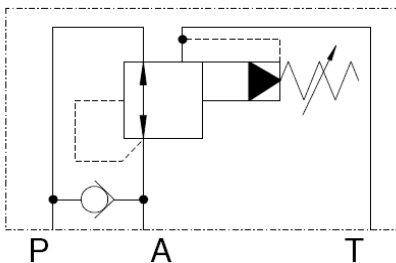

Pressure Reducing Valve pilot operated Subplate to ISO 24340 VP-DRP6

SYMBOL



up to 350 bar
up to 60 l/min

FEATURES

- Hole pattern to ISO 24340, Nominal size 6
- Pilot operated pressure reducing valve
- Full backflow in the opposite direction by built-in check valve (cracking pressure 0,5 bar)

SPECIFICATIONS

Operating pressure:	max. 350 bar
Flow rate:	max. 60 l/min
Leakage (internal):	< 0,5 l/min
Fluids:	Hydraulic oil to DIN 51524 part 1 and 2
Temp. range of the operating fluid:	-20°C up to max. +80°C
Ambient temperature range:	-20°C up to max. +50°C
Viscosity range:	7,4 – 400 mm ² /s is recommended
Filtration:	Class 21/19/16 according to ISO4406
Installation:	no orientation restrictions
Hole pattern:	ISO 24340 Form A6
Weight:	1,2 kg

PERFORMANCE

measured at $v = 36 \text{ mm}^2/\text{s}$ and $T_{\text{oil}} = 50^\circ \text{C}$

Pressure Drop $\Delta p / Q$

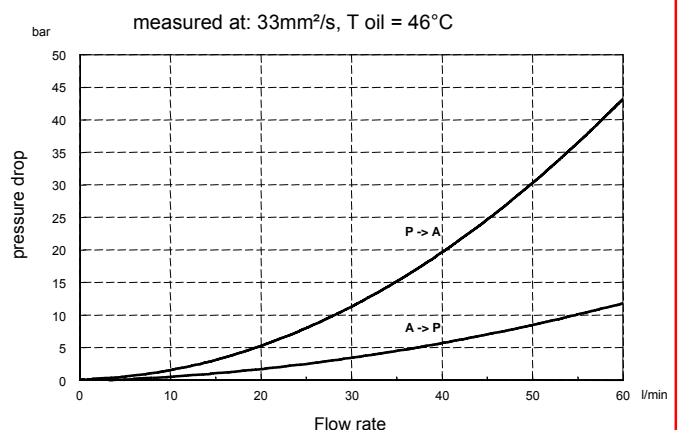
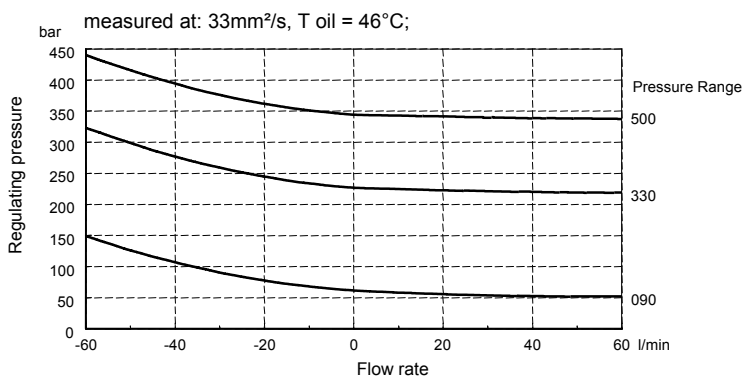

Models on request

VP-DRP6 090VR S01/N
 VP-DRP6 330VR S01/N
 VP-DRP6 500VR S01/N

Part No.

3497267
 3497268
 3497269

MODEL CODE

VP-DRP6 090 VR S01/V

Name and size _____
 Pressure reducing valve pilot operated NW 6

Pressure ranges

090 = up to 60 bar
 330 = up to 230 bar
 500 = up to 350 bar

Adjustment

V = adjustable by tool

Check valve

R (cracking pressure 0,5 bar)

Type

S01 = Standard

Seals

V = FKM (Standard)
 N = NBR

DIMENSIONS

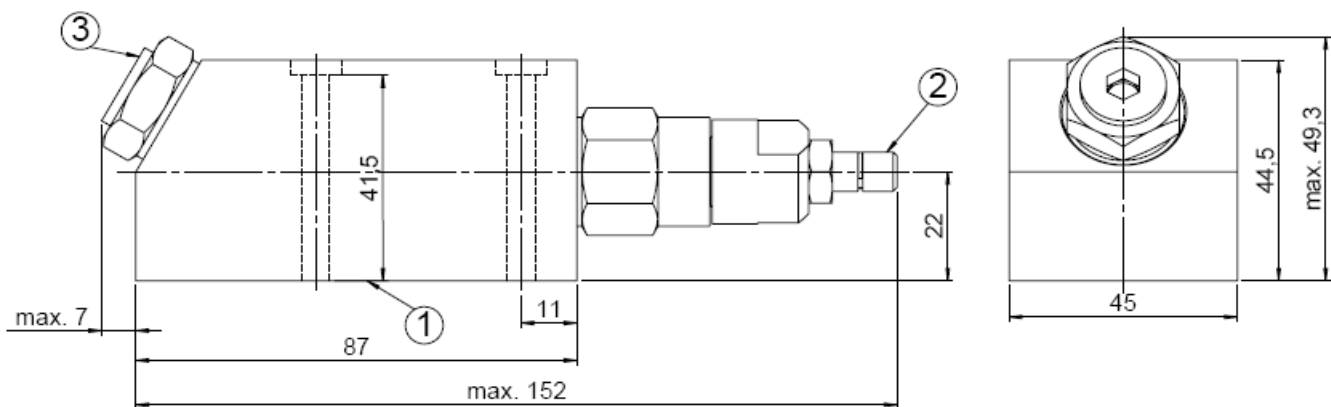

- 1) Mounting plate with O-rings: 4x O-Ring 9,25 x 1,78 FKM
- 2) Pressure reducing valve adjustable by tool
- 3) Check valve

Fastening screws: 4x Allen key M5 x 50 10.9

Torque: 5 Nm + 0,5 Nm

All dimensions in mm. Fastening elements are not in the scope of delivery.

Mounting plate to ISO 24340 Form A6

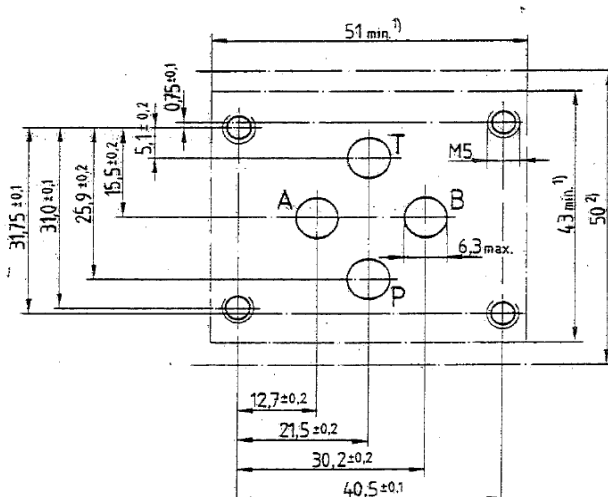

Annotation

The technical information in this brochure are relating to the operating conditions and applications.

At deviant applications and/or operating conditions please contact the technical dept.

Technical information are subject to technical modifications.

HYDAC Fluidtechnik GmbH
 Justus-von-Liebig-Str. 5
 66280 Sulzbach / Saar
 Tel.: 06897 / 509 -0
 Fax: 06897 / 509 -598
 Email: flutec@hydac.com



Flow Regulator pressure-compensated Subplate to ISO6263 VP-2SR6

SYMBOL

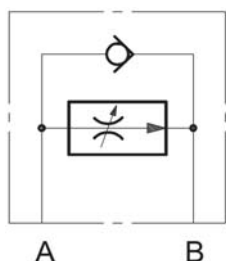

Up to 250 bar
Up to 30 l/min

FUNCTION

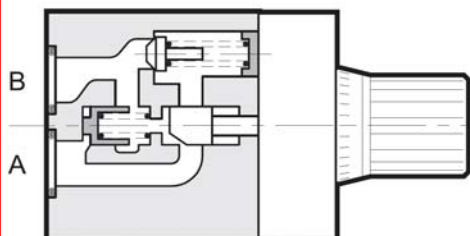

FEATURES

- Hole pattern to ISO 6263-03, Nominal size 6
- Adjustable flow control valve subplate mounting for flow control in one direction and full backflow in the opposite direction
- Independent from pressure by integrated pressure compensator
- Adjustable by turning knob

SPECIFICATIONS

Operating pressure:	max. 250 bar
Minimal pressure difference:	max. 10 bar between A and B
Flow rate:	max. 0,5 / 1 / 4 / 10 / 16 / 22 / 30 l/min
	max. 40 l/min by the check valve (cracking pressure 0,5 bar)
Minimal adjustable Flow rate:	0,025 l/min
Operating fluid:	hydraulic oil to DIN 51524 part 1 and 2
Operating fluid temp. range:	-20°C up to max. +80°C
Ambient temperature range:	-20°C up to max. +50°C
Viscosity range:	7,4 – 400 mm ² /s is recommended
Filtration:	Class 20/18/15 according to ISO 4406
Weight:	1,3 kg

PERFORMANCE

measured at $v = 36 \text{ mm}^2/\text{s}$ and $T_{\text{oil}} = 50^\circ \text{C}$

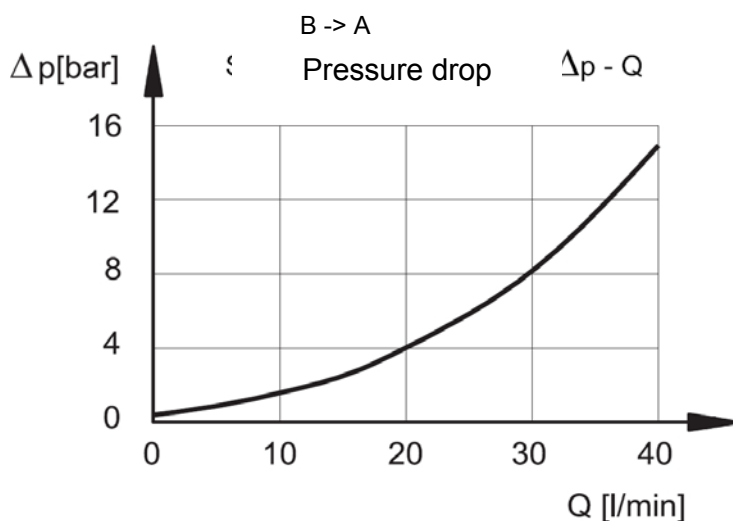
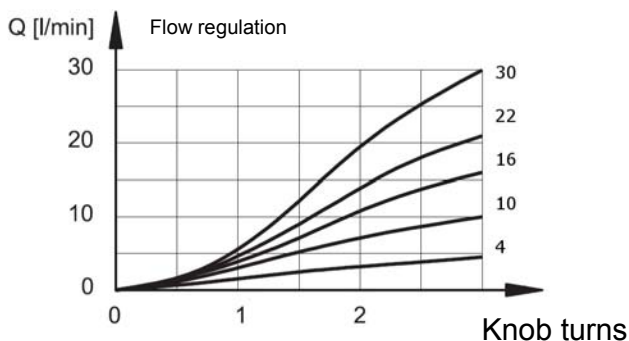
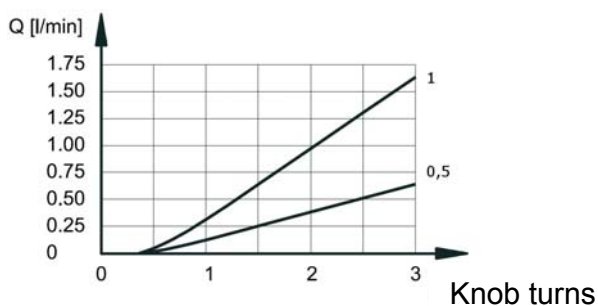

Standard models

Standard models	Part No.
VP-2SR6 D05SR S01/V	3541093
VP-2SR6 D1SR S01/V	3541094
VP-2SR6 D4SR S01/V	3541166
VP-2SR6 D10SR S01/V	3541169
VP-2SR6 D16SR S01/V	3541172
VP-2SR6 D22SR S01/V	3541173
VP-2SR6 D30SR S01/V	3541175
Other models on request	

Part No.

MODEL CODE

	<u>VP-2SR6</u>	<u>D 05</u>	<u>S R</u>	<u>S01 / V</u>
Name and size	2-way flow control valve nominal size 6			
Curve	D = depressive			
Flow rate code	05 = 0,5 l/min 1 = 1 l/min 4 = 4 l/min 10 = 10 l/min 16 = 16 l/min 22 = 22 l/min 30 = 30 l/min			
Turning knob with scale				
Check valve	R (cracking pressure 0,5 bar)			
Type	S01 = Standard			
Seal material	V = FKM (Standard) N = NBR			

DIMENSIONS

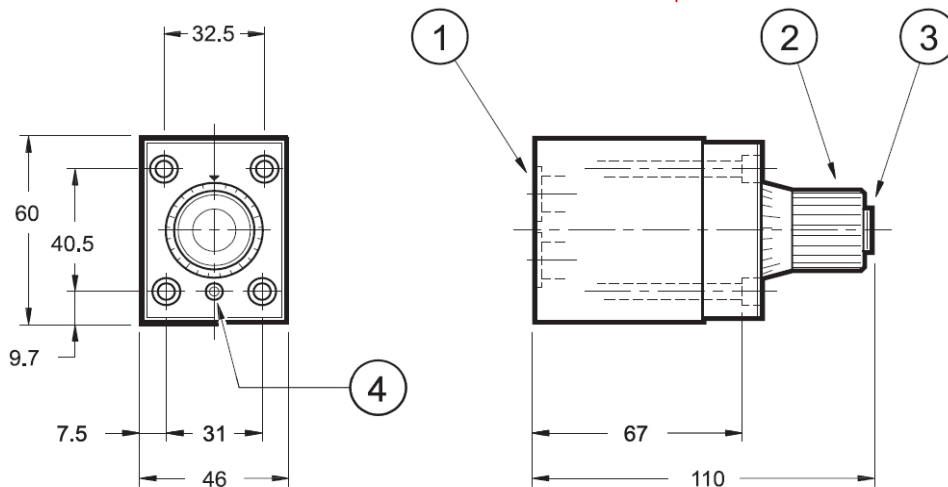

- 1) Mounting plate with O-rings:
2x 14 x 2 FKM
- 2) Turning knob (3 turns) by
turning clockwise the flow is rising
- 3) Regulation steps of the turning knob
- 4) Fastening screw of the
turning knob

Fastening screws:
4x Allen key M5x75 10.9
Torque: 5 Nm + 0,5 Nm

All dimensions in mm.
Fastening elements are not in the scope
of delivery.

Mounting plate to ISO 6263-03-03-*-97

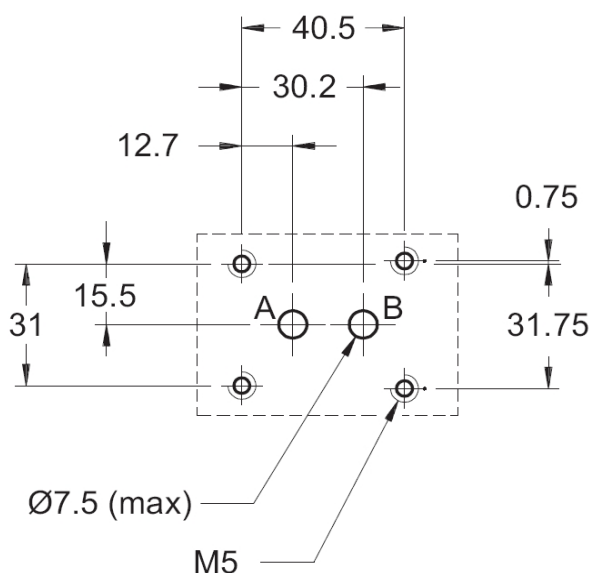

Annotation
The technical information in this
brochure are relating to the operating
conditions and applications.
At deviant applications and/or
operating conditions please contact
the technical dept.
Technical information are
subject to technical modifications.

HYDAC Fluidtechnik GmbH
Justus-von-Liebig-Str. 5
66280 Sulzbach / Saar
Tel.: 06897 / 509 -0
Fax: 06897 / 509 -598
Email: flutec@hydac.com