

# Programming tools for digital electronics

Atos PC software, USB adapters, cables and terminators

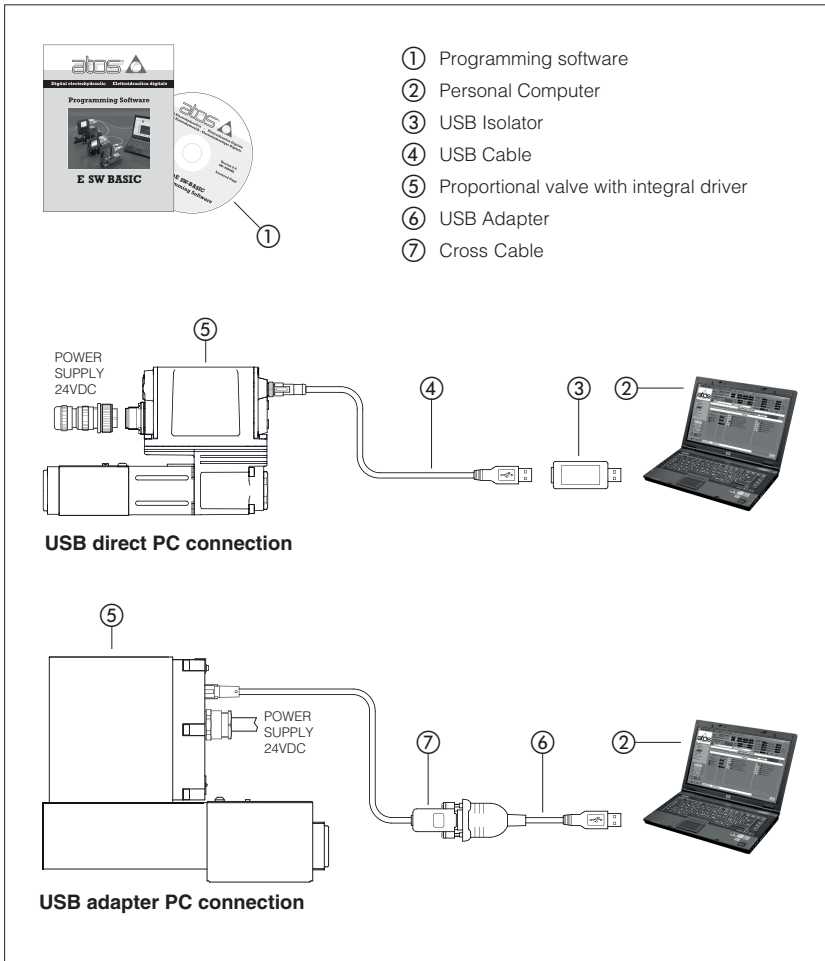

The E-SW / Z-SW programming software are the entry door to the Atos digital technology. They are supplied in DVD format and can be easily installed on a desktop or a notebook computer.

The intuitive graphic interface allows to:

- set up valve's functional parameters
- verify the actual working conditions
- identify and quickly solve fault conditions
- adapt the factory preset parameters to the application requirements
- store the customized setting into the valve
- archive the customized setting into the PC

The graphic interface is organized in pages related to different specific groups of functions and parameters.

The software automatically recognizes the connected valve model and adapts the displayed parameter groups, according to the selected access level.

The programming software is available in different versions according to the driver and controller communication interfacing (see section 1).

Fieldbus communication software (BC, BP, EH and EW) includes also dedicated manuals and configuration files for user self management of the Atos electronics, using a fieldbus master.

**Features:**

- automatic valve recognition
- multilevel graphic interface
- numeric parameters settings (scale, bias, ramp, linearization, dither, etc.)
- real-time parameters modification
- diagnostic and monitor signals
- preset data storing into the digital driver and controller
- internal oscilloscope function
- internal database of customized preset

**DVD contents:**

- software installer
- user manuals
- fieldbus communication manuals and configuration files (BC, BP, EH, EW)

**1 PROGRAMMING SOFTWARE**

Valve's functional parameters can be easily set up with Atos E-SW / Z-SW programming software using proper connection to the digital driver/controller.

<b>E - SW</b>	-	<b>BASIC</b>	/	<b>*</b>	-	<b>*</b>
<p><b>E-SW</b> = for valve drivers</p> <p>Supported communication interfaces:</p> <p><b>BASIC</b> = NP (USB)      PS (Serial)      IR (Infrared)</p> <p><b>FIELDBUS</b> = BC (CANopen)      BP (PROFIBUS DP)</p> <p>                  EH (EtherCAT)      EW (POWERLINK)</p>				<p>Supplies:</p> <p>- = first supply</p> <p><b>N</b> = next supply</p>		
				<p>Option:</p> <p><b>PQ</b> = for drivers with alternated P/Q controls SP, SF, SL</p>		

**Notes:** E-SW-FIELDBUS allows EtherCAT and POWERLINK drivers programming only through USB or Serial communication port  
E-SW-\*/PQ software supports the programming of valves without alternated P/Q control SP, SF, SL

<b>Z - SW</b>	-	<b>FULL</b>	-	<b>*</b>
<p><b>Z-SW</b> = for axis controllers</p> <p>Supported communication interfaces:</p> <p><b>FULL</b> = NP (USB)      PS (Serial)</p> <p>          BC (CANopen)      BP (PROFIBUS DP)</p> <p>          EH (EtherCAT)      EW (POWERLINK)</p>				<p>Supplies:</p> <p>- = first supply</p> <p><b>N</b> = next supply</p>

**Note:** Z-SW-FULL allows EtherCAT and POWERLINK controllers programming only through USB communication port

Free programming software, **web download**:

**E-SW-BASIC** Software can be downloaded upon web registration at [www.download atos.com](http://www.download atos.com); service and DVD not included  
 Upon web registration user receive via email the Activation Code (software free license) and login data to access Atos Download Area  
 The software remains active for 10 days from the installation date and then it stops until the user inputs the Activation Code

**DVD first supply** of programming software, **to be ordered separately**:

**E-SW-BASIC** Software has to be activated via web registration at [www.download atos.com](http://www.download atos.com); 1 year service included  
**E-SW-BASIC/PQ** Upon web registration user receive via email the Activation Code (software license) and login data to access personal Atos Download Area.  
**E-SW-FIELDBUS**  
**E-SW-FIELDBUS/PQ** The software remains active for 10 days from the installation date and then it stops until the user inputs the Activation Code  
**Z-SW-FULL**

**DVD next supplies** of programming software, **to be ordered separately**:

**E-SW-BASIC-N** Only for supplies after the first; service not included, web registration not allowed  
**E-SW-BASIC/PQ-N** Software has to be activated with Activation Code received upon first supply web registration  
**E-SW-FIELDBUS-N**  
**E-SW-FIELDBUS/PQ-N**  
**Z-SW-FULL-N**

**Note:** the software BASIC, FIELDBUS and FULL are NOT interchangeable and must be ordered separately

Programming software FIELDBUS and FULL can program digital electronics through:

- USB communication port for all standard versions of drivers/controllers
- RS232 Serial communication port for all versions of AES s30 drivers and Z-ME-KZ-PS s11 controllers

**DVD contents**

Include software installer, user manuals and fieldbus configuration files (EDS for BC, GSD for BP, XML for EH and XDD for EW).

**Atos Download Area**

Direct access to latest releases of programming software, manuals, USB drivers and fieldbus configuration files at [www.download atos.com](http://www.download atos.com)

Software and USB drivers can be easily installed following the instruction contained in the "info.txt" files.

An automatic mailing message will inform all the registered users whenever a new software upgrade is available.

**E-SW / Z-SW minimum PC requirements**

<b>Personal Computer</b>	Pentium® processor 1GHz or equivalent	<b>Memory</b>	512 MB RAM + Hard Disk with 250MB free space
<b>Operating System</b>	Windows XP SP3	<b>Device</b>	Dvd reader
<b>Monitor Resolution</b>	1024 x 768	<b>Interface</b>	RS232 serial port (only for PS) or USB port

**2 USB - ISOLATOR AND CABLE**

E-SW / Z-SW software permit valve's parameterization through USB port.

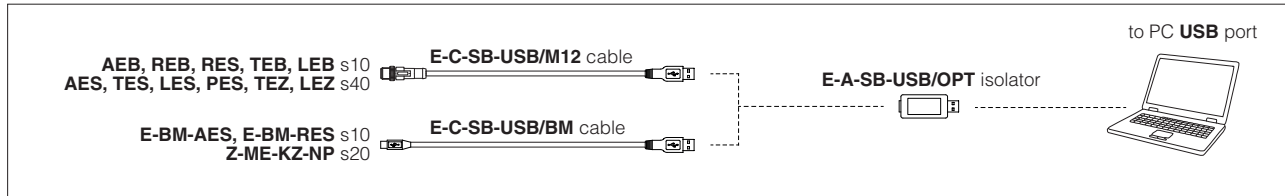

**WARNING: drivers/controllers USB port is not isolated!** Use of USB isolator adapter is highly recommended for PC protection: wrong earthing connections may cause high potential difference between GNDs, generating high currents that could damage the PC connected to drivers/controllers.

**2.1 E-A-SB-USB/OPT** - isolator adapter from PC USB port to USB cables

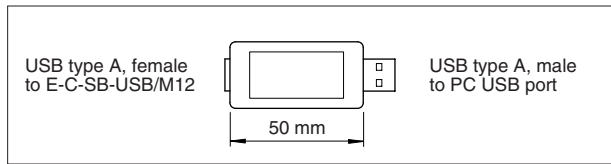

- USB 2.0 Full speed (12 MBps)
- electrical isolation 1 kV
- temperature range, -40° ÷ +50° (relative humidity 25% ÷ 75%)
- external power supply not required (power 400 mA output, 5 V ±10%)
- MTBF >1,2 million hours (MIL standard)

**2.2 E-C-SB-USB/M12** - 4 m cable

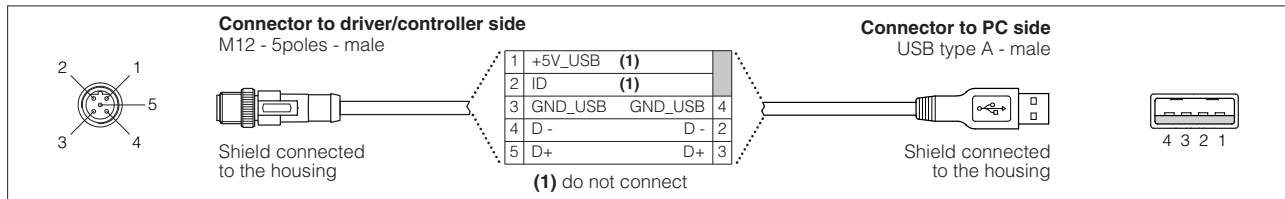

**2.3 E-C-SB-USB/BM** - 3 m cable

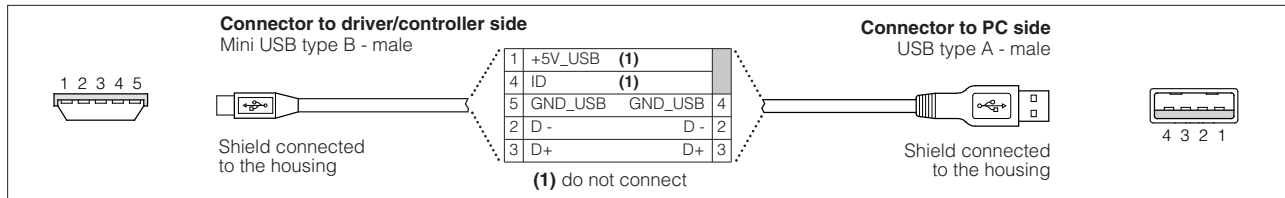

### 3 IR infrared - USB COMMUNICATION ADAPTER

The adapter have to be connected to the USB communication port of PC to activate the IR infrared communication interface towards Atos digital electrohydraulics.

#### 3.1 Connection tools

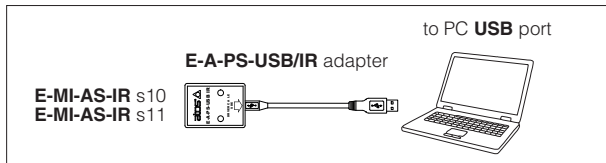

#### 3.2 E-A-PS-USB/IR - 3 m adapter

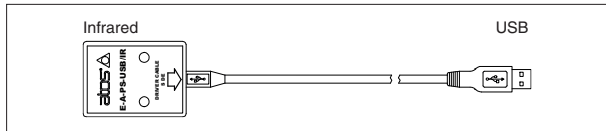

- direct infrared communication with the driver
- USB male connector, type A
- plug-in format for direct infrared connection on the driver
- transmission rate 9,6 kbit/s
- external power supply not required (USB supply)

### 4 PS serial RS232 - USB COMMUNICATION ADAPTER AND CROSS CABLES

The adapter have to be connected to the USB communication port of PC to activate the PS RS232 serial communication interface towards Atos digital electrohydraulics. The cross cables connect the relevant connector of the USB adapter with the communication port of the digital drivers/controllers.

#### 4.1 Connection tools

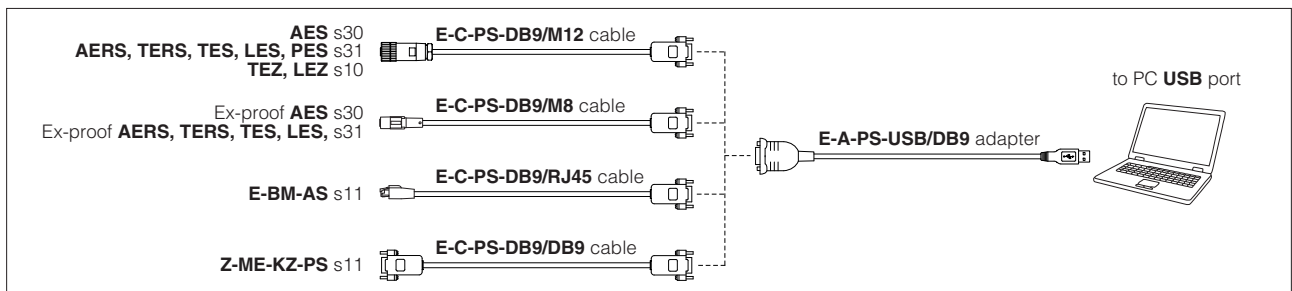

**Note:** the adapter is not required if PC is already equipped with a RS232 serial communication port

#### 4.2 E-A-PS-USB/DB9 - 0,45 m adapter

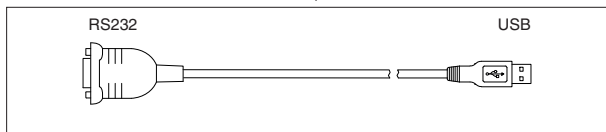

- DB9 male connector according to RS232 serial specification
- USB male connector, type A
- transmission rate from 1,6 kbit/s up to 225 kbit/s
- external power supply not required (USB supply)

#### 4.3 E-C-PS-DB9/M12 - 4 m cable

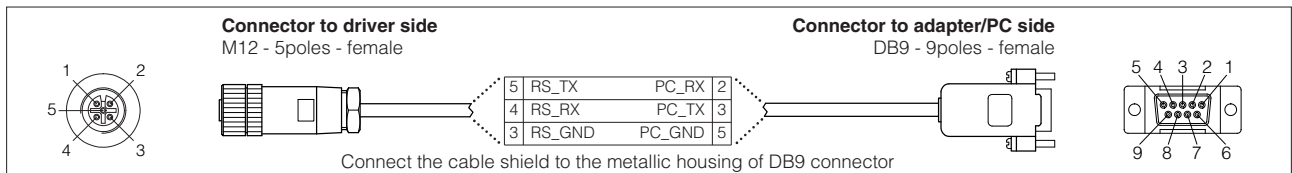

#### 4.4 E-C-PS-DB9/M8 - 4 m cable

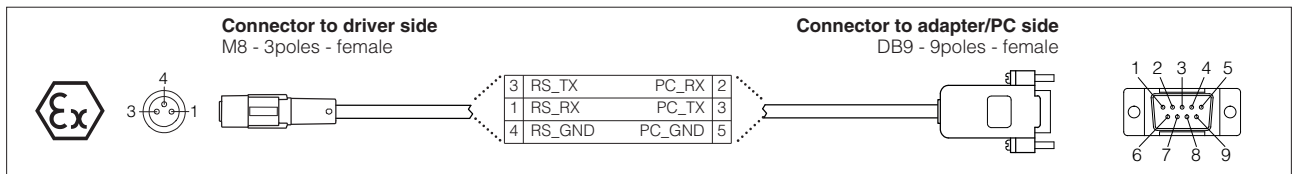

#### 4.5 E-C-PS-DB9/RJ45 - 2,5 m cable

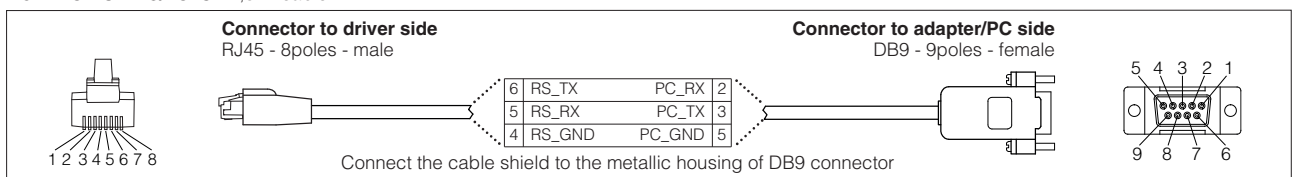

#### 4.6 E-C-PS-DB9/DB9 - 4 m cable

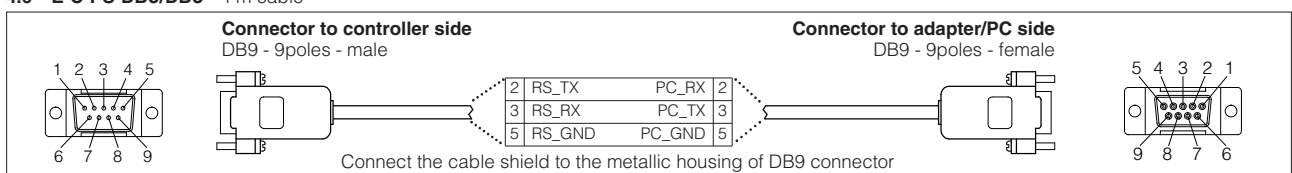

## 5 BC CANbus - USB COMMUNICATION ADAPTER AND CROSS CABLES

The adapter have to be connected to the USB communication port of PC to activate the BC CANbus communication interface towards Atos digital electrohydraulics. The cross cables connect the relevant connector of the USB adapter with the communication port of the digital drivers/controllers.

### 5.1 Connection tools

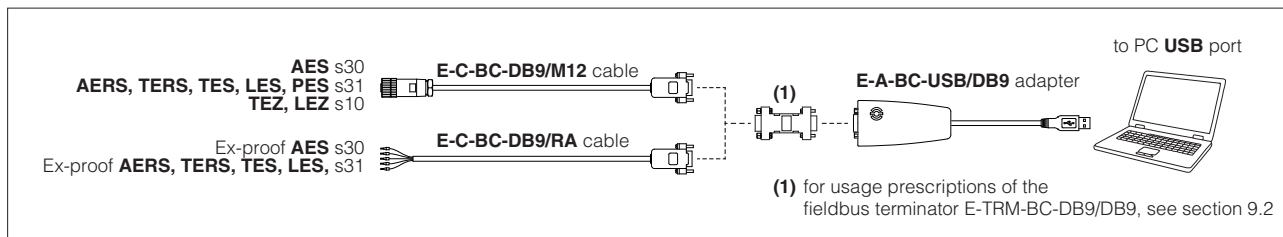

**Note:** for AES s30 drivers, the CANbus adapter and cable are not required since driver programming can be performed via RS232 communication port, see 4.1

### 5.2 E-A-BC-USB/DB9 - 2 m adapter

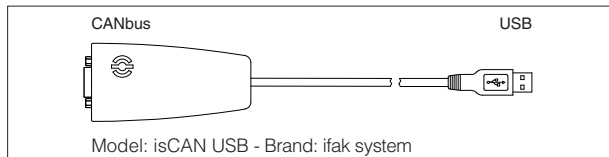

- DB9 male connector according to the CiA specification DR303-1
- USB male connector, type A
- transmission rate from 10 kbit/s to 1 Mbit/s
- external power supply not required (USB supply)
- LEDs indicate the actual working condition

### 5.3 E-C-BC-DB9/M12 - 2 m cable

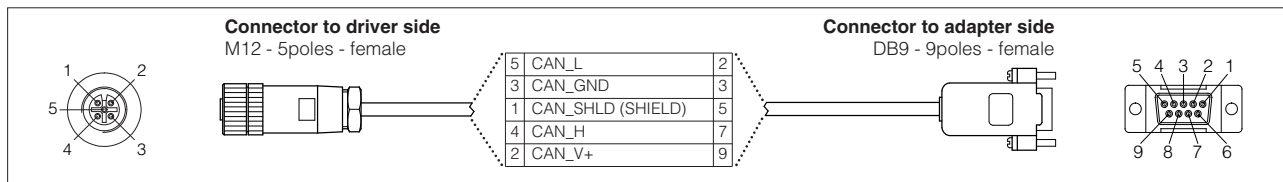

### 5.4 E-C-BC-DB9/RA - 2 m cable

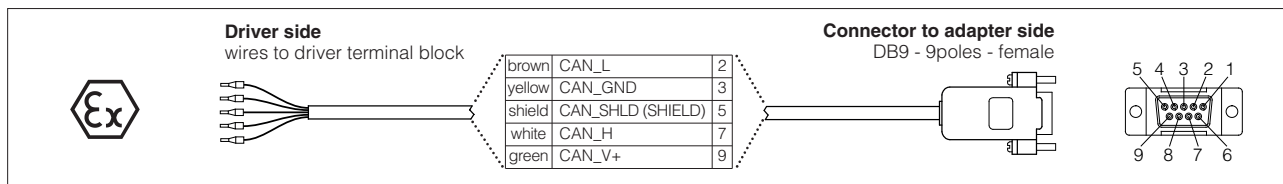

## 6 BP PROFIBUS - USB COMMUNICATION ADAPTER AND CROSS CABLES

The adapter have to be connected to the USB communication port of PC to activate the BP PROFIBUS communication interface towards Atos digital electrohydraulics. The cross cables connect the relevant connector of the USB adapter with the communication port of the digital drivers/controllers.

### 6.1 Connection tools

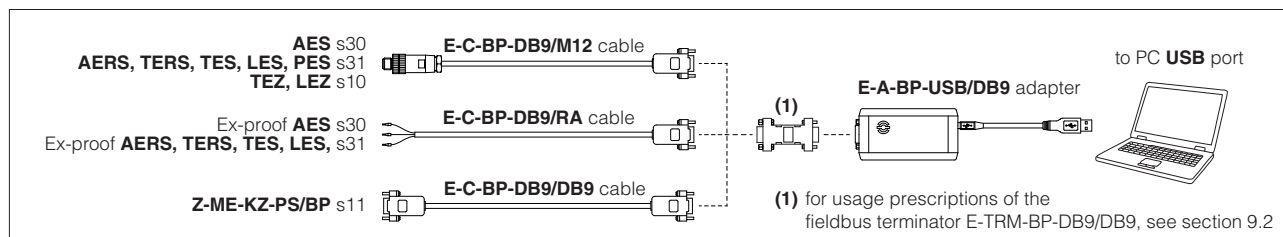

**Note:** for AES s30 drivers and Z-ME-KZ-PS/BP s11 controllers, the PROFIBUS adapter and cable are not required since driver programming can be performed via serial RS232 communication port, see 4.1

### 6.2 E-A-BP-USB/DB9 - 2 m adapter

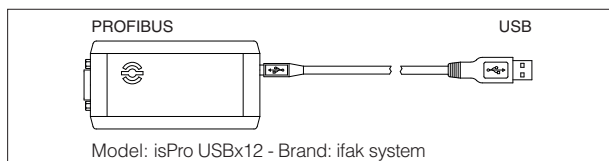

- DB9 female connector according to the PROFIBUS RS485 specification
- USB male connector, type A
- transmission rate from 1,6 kbit/s to 12 Mbit/s
- external power supply not required (USB supply)
- LEDs indicate the actual working condition

### 6.3 E-C-BP-DB9/M12 - 2 m cable

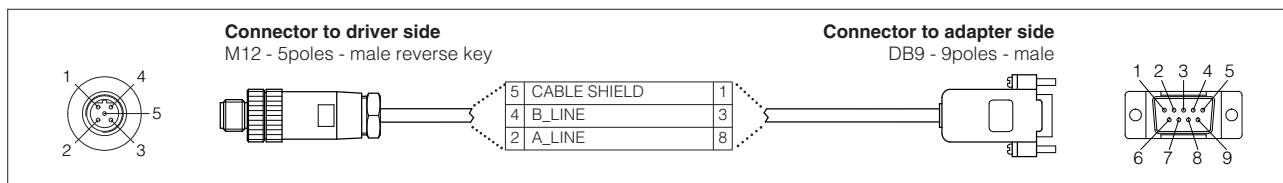

### 6.3 E-C-BP-DB9/RA - 2 m cable

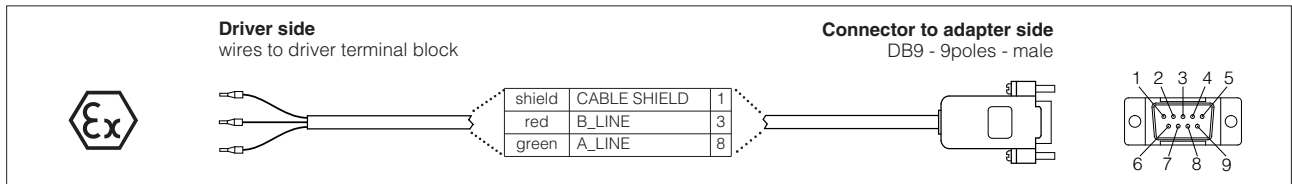

### 6.4 E-C-BP-DB9/DB9 - 2 m cable

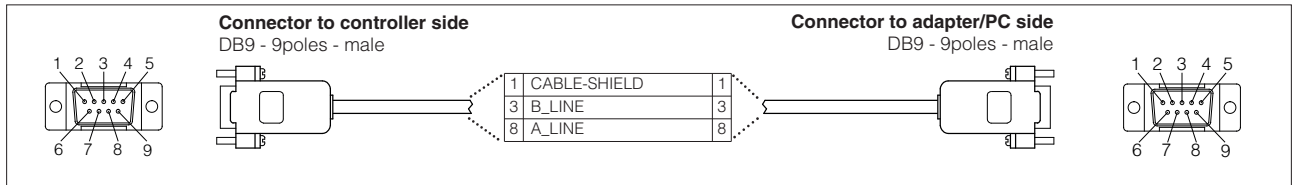

## 7 EtherCAT AND POWERLINK CABLE WIRING DIAGRAM

Typical EtherCAT and POWERLINK cable wiring diagram from industrial M12 connectors to standard RJ45 ethernet connectors.

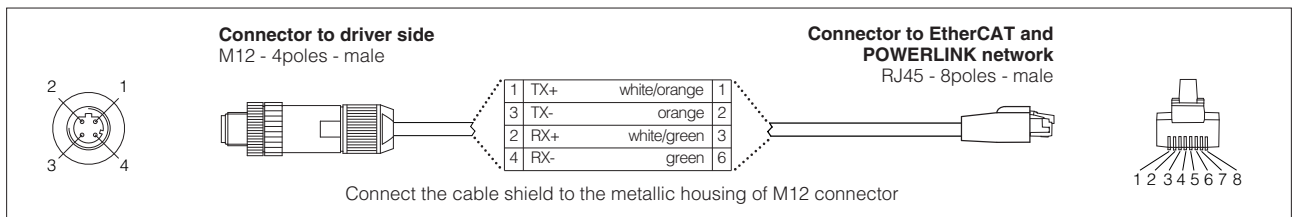

## 8 FIRMWARE UPDATE

It is possible to update the firmware of the following digital drivers and controllers using proper USB or RS232 serial communication port:

<b>USB</b>	E-RI-AEB s10 E-RI-AES s40	E-RI-REB s10 E-RI-RES s10	E-BM-AES s10 E-BM-RES s10	E-RI-TEB s10 E-RI-LEB s10	E-RI-TES s40 E-RI-LES s40	E-RI-TES-S s40 E-RI-LES-S s40	E-RI-PES-S s40	Z-RI-TEZ s40 Z-RI-LEZ s40	Z-ME-KZ s20
<b>RS232 Serial</b>	E-RI-AES s30	Z-ME-KZ s11							

## 9 FIELDBUS TERMINATORS

For CANopen (BC) or PROFIBUS DP (BP) the fieldbus terminator has to be used.

<b>E - TRM</b>	-	<b>BC</b>	-	<b>M12</b>	/	<b>5PM</b>
Terminator  Fieldbus interfaces: <b>BC</b> = CANopen <b>BP</b> = PROFIBUS DP						Connector: <b>5PM</b> = to BC executions, drivers/controllers (1) <b>4PF</b> = to BP executions, drivers/controllers (1) <b>DB9</b> = to DB9 connector, cable side  Connector: <b>M12</b> = from M12 output fieldbus connector, drivers/controllers (1) <b>DB9</b> = from DB9 connector, adapter side

**Note:** for TES, LES, PES, TEZ, LEZ series 40

### 9.1 M12 - terminators characteristics

The fieldbus terminators for CANopen and PROFIBUS DP are required when USB adapter has to be connected directly to the digital driver/controller or output fieldbus connector has to be used as network end point.

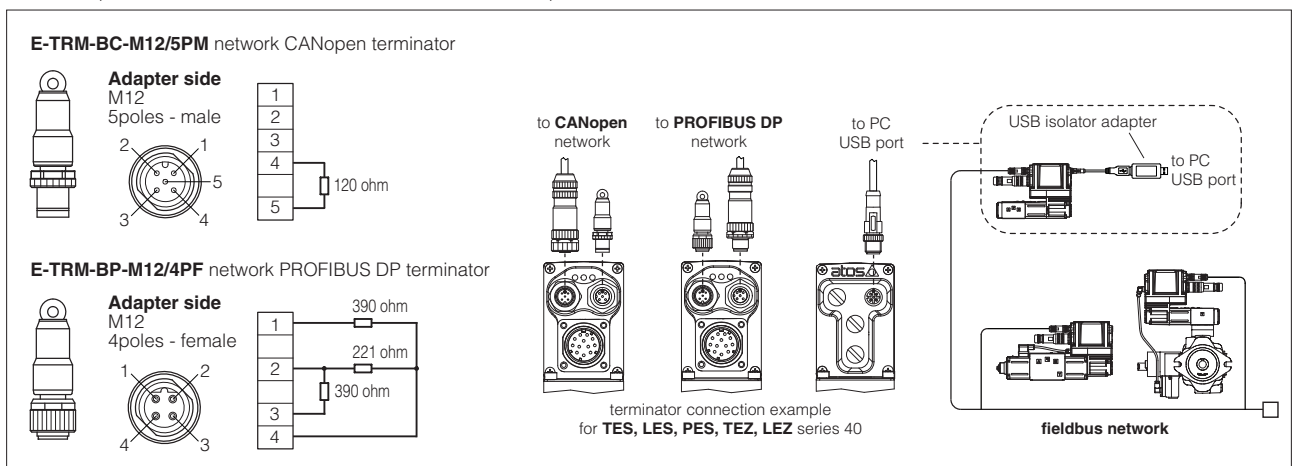

## 9.2 DB9 - terminators characteristics

The fieldbus terminators for CANopen and PROFIBUS DP are required when USB adapter has to be connected directly to the digital driver/controller.

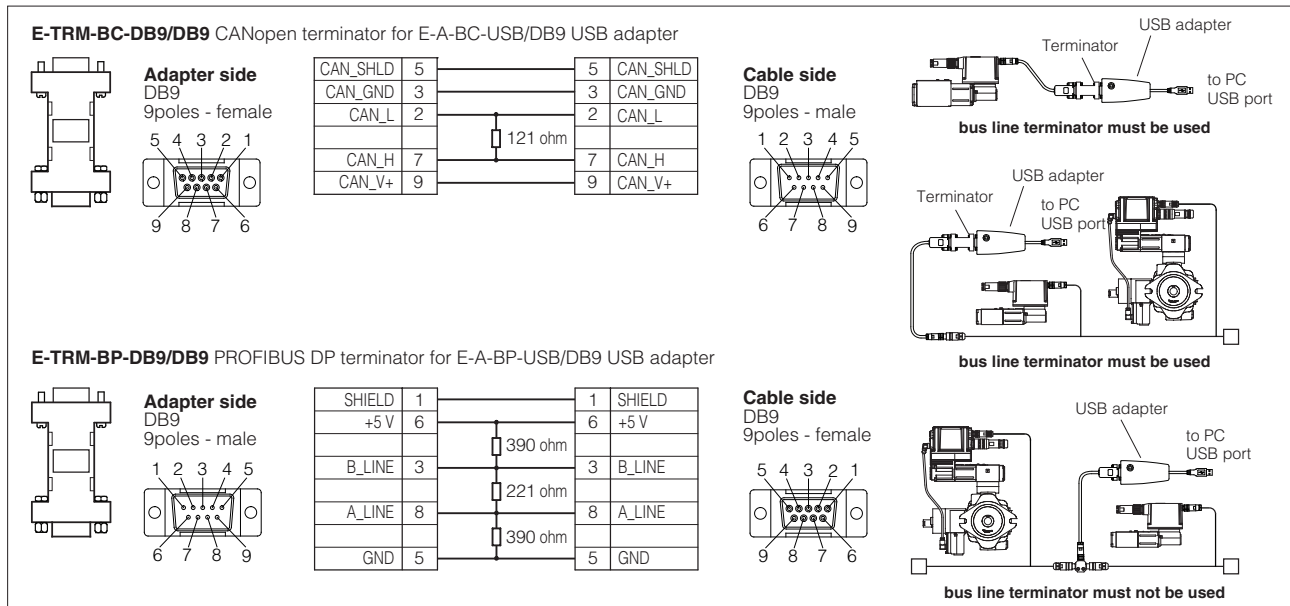

## 10 RECOMMENDED TOOLS SELECTION

### 10.1 Standard electronics

	Model Code	Series	Software	Cable	USB Adapter	Terminator
IR	E-MI-AS-IR	11			E-A-PS-USB/IR	
PS	E-BM-AS	11		E-C-PS-DB9/RJ45	E-A-PS-USB/DB9	
	E-BM-AES, E-BM-RES	10	E-SW-BASIC	E-C-SB-USB/BM		
NP	AEB, REB	10				
	TEB, LEB, TES, LES	40		E-C-SB-USB/M12	E-A-SB-USB/OPT	
	TES, LES, PES with SP, SF, SL options	40	E-SW-BASIC/PQ			
	Z-ME-KZ-NP	20	Z-SW-FULL	E-C-SB-USB/BM		
	TEZ, LEZ	40		E-C-SB-USB/M12		
BC	E-BM-AES, E-BM-RES	10		E-C-SB-USB/BM		
	RES	10	E-SW-FIELDBUS			
BP	AES, TES, LES	40		E-C-SB-USB/M12	E-A-SB-USB/OPT	
	TES, LES, PES with SP, SF, SL options	40	E-SW-FIELDBUS/PQ			
EH	Z-ME-KZ-NP/*	20	Z-SW-FULL	E-C-SB-USB/BM		
	TEZ, LEZ	40		E-C-SB-USB/M12		
EW	TES, LES	40	E-SW-FIELDBUS			
	TES, LES, PES with SP, SF, SL options	40	E-SW-FIELDBUS/PQ	E-C-SB-USB/M12	E-A-SB-USB/OPT	
	TEZ, LEZ	40	Z-SW-FULL			

### 10.2 Ex-proof electronics

	Model Code	Series	Software	Cable	USB Adapter	Terminator
PS	AES	30	E-SW-BASIC	E-C-PS-DB9/M8		
	AERS, TERS, TES, LES	31				
BC	AES	30		E-C-PS-DB9/M8	E-A-PS-USB/DB9	
	AERS, TERS, TES, LES	31	E-SW-FIELDBUS	E-C-BC-DB9/RA	E-A-BC-USB/DB9	E-TRM-BC-DB9/DB9
BP	AES	30		E-C-PS-DB9/M8	E-A-PS-USB/DB9	
	AERS, TERS, TES, LES	31		E-C-BP-DB9/RA	E-A-BP-USB/DB9	E-TRM-BP-DB9/DB9

### 10.3 Phase out electronics

	Model Code	Series	Software	Cable	USB Adapter	Terminator
IR	E-MI-AS-IR	10	E-SW-IR		E-A-PS-USB/IR	
PS	AES	30	E-SW-BASIC			
	AERS, TERS, TES, LES	31		E-C-PS-DB9/M12	E-A-PS-USB/DB9	
	TES, LES, PES with SP, SF, SL options	31	E-SW-BASIC/PQ			
	TEZ, LEZ	10	Z-SW-FULL			
	Z-ME-KZ-PS	11		E-C-PS-DB9/DB9		
BC	AES	30	E-SW-FIELDBUS	E-C-PS-DB9/M12	E-A-PS-USB/DB9	
	AERS, TERS, TES, LES	31				
	TES, LES, PES with SP, SF, SL options	31	E-SW-FIELDBUS/PQ	E-C-BC-DB9/M12	E-A-BC-USB/DB9	E-TRM-BC-DB9/DB9
	TEZ, LEZ	10	Z-SW-FULL			
BP	AES	30	E-SW-FIELDBUS	E-C-PS-DB9/M12	E-A-PS-USB/DB9	
	AERS, TERS, TES, LES	31				
	TES, LES, PES with SP, SF, SL options	31	E-SW-FIELDBUS/PQ	E-C-BP-DB9/M12	E-A-BP-USB/DB9	E-TRM-BP-DB9/DB9
	TEZ, LEZ	10	Z-SW-FULL			
	Z-ME-KZ-PS/BP	11		E-C-PS-DB9/DB9	E-A-PS-USB/DB9	
EH	AES	30	E-SW-FIELDBUS	E-C-PS-DB9/M12	E-A-PS-USB/DB9	