

JC.3.D... HEAVY DUTY SINGLE JOYSTICK BASE



JC3D...

This is a rugged joystick with single axis Y potentiometer and ergonomic handle. The joystick has a spring return lever for center position. The panel material for this joystick and thickness must be strong and rigid. The panel thickness should have a dimension of minimum 3.5mm and maximum 6mm. The joystick has two directional micro-switches per Y axis. The handle has 3 pushbuttons and it is possible to have the operator present trigger too.

The IP protection of joystick is referred to above mounting panel and it can be max. IP65. N.B. below mounting panel the rating is IP40.

APPLICATIONS

The joystick has been designed for aerial platform, agricultural and forestry machinery. The use of this product with the Aron electronic control unit for non contemporary movements gives the maximum advantage for hydraulic solutions controlled with a proportional valve.

ORDERING CODE

JC	Heavy duty single Joystick
3	Handle (3 switches)
D	Directional switches
1	Functional operation single axis (Y)
A	With operator present trigger switch
**	00 = No variants GD = With silicon rubber protection on the switches handle
1	Serial number

Electrical features	
Potentiometer resistance	1.4 ÷ 2.2 KΩ
Max. supply voltage	VDD = 32V DC
Max. supply voltage Y pot	0 – 100% VDD
Max. output current	5 mA

Directional switches	
Maximum supply voltage	VCC = 32V DC
Max. output current	200 mA
	Resistive load

Mechanical features	
Mechanical angle	± 20°
Maximum operating load	390 N
(Measured 130 mm above the mounting surface)	
Mechanical Life (Y axis)	7.500.000 cycles
Weight (handle include)	0,900 Kg

Ambient operating temperature	-40°C ÷ +80°C
Protection according to DIN	IP65
Shocks	Level 20G Type ½ sine 6ms
	Number of shocks 1350 per axis

•  Registered mark for industrial environment with reference to the compatibility. European norms:

- IEC 61000-4-3 "Electromagnetic immunity"
- EN6550022 "Electromagnetic emissions"

• Product in accordance with **RoHS** 2011/65/UE Europe Directive.

9

Connectors and electrical contacts included in the furniture.

POTENTIOMETER OUTPUT AXIS Y

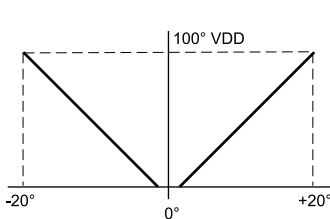

In order to obtain the Y axis output signal from the joystick as indicated in the diagram over it is necessary to connect the pin 9 and 11 of the AMP 16 way connector at +VDD, and to connect the pin 12 of the AMP 16 way connector at 0V.

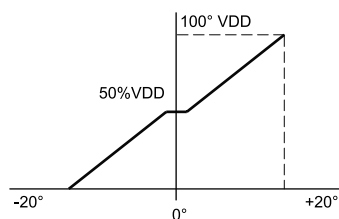

In order to obtain the Y axis output signal from the joystick as indicated in the diagram over it is necessary to connect the pin 9 of the AMP 16 way connector at 0V, and to connect the pin 11 of the AMP 16 way connector at +VDD.

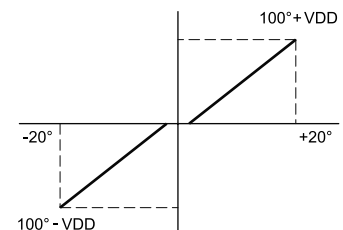

In order to obtain the Y axis output signal from the joystick as indicated in the diagram over it is necessary to connect the pin 9 of the AMP 16 way connector at -VDD, and to connect the pin 11 of the AMP 16 way connector at +VDD.

CONNECTOR CONFIGURATION AND PIN ALLOCATION DETAIL

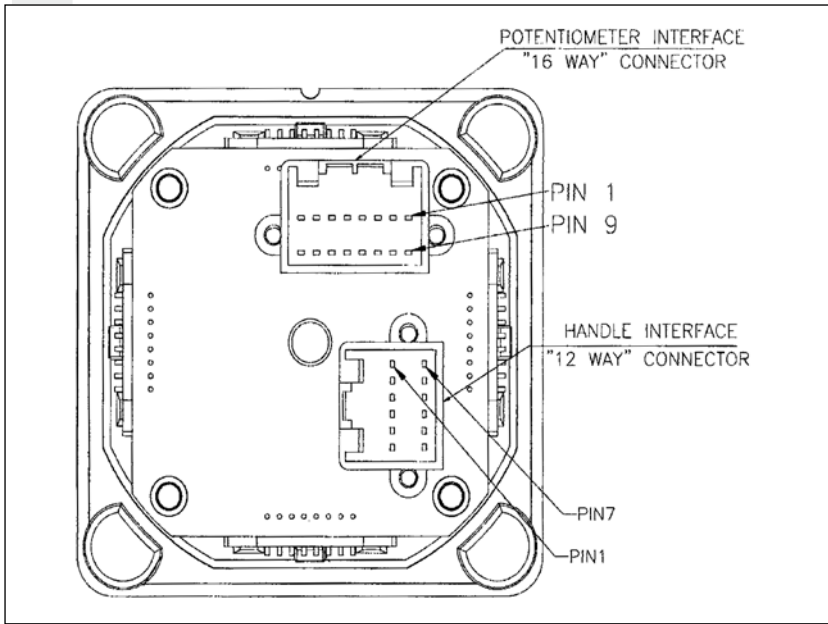

12 WAY HANDLE CONNECTIONS

AMP	Pin allocation description
2	Switch 3 - contact N/O
3	Switch 2 - contact N/O
4	Switch 1 - contact N/O
8	Operator present trigger switch
11	Switch track common
12	Operator present trigger switch

OVERALL DIMENSIONS

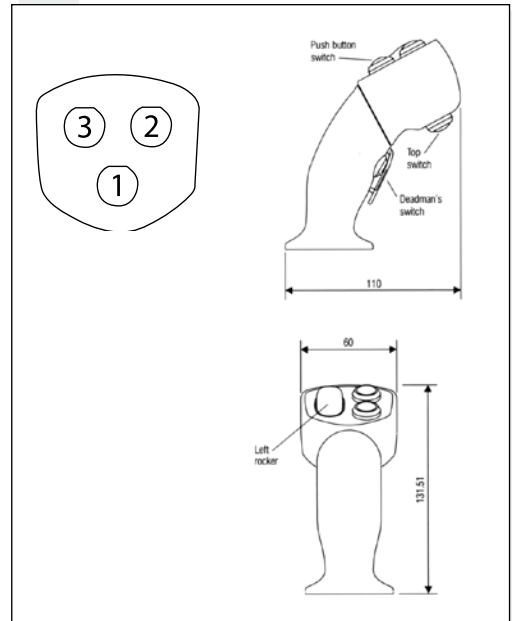

**FROM THE 16 WAY PRIMARY POTENTIOMETER CONNECTIONS
SINGLE POTENTIOMETER PER Y AXIS**

AMP	Pin allocation description
1	Y Switch track forward
9	Y Pot track back
10	Y Pot track signal
11	Y Pot track forward
12	Y Pot track centre tap
13	Y Switch track common
14	Y Switch track back
16	Y Switch track centre on

SPARE PARTS AMP 040 SERIES MULTILOCK

Receptacle contacts
P.No. 175062-1* Loose piece

Plug housing 12 position
P.No. 174045-2*

Plug housing 16 position double row
P.No. 174046-2*

* AMP code

Spare parts kit, connectors and electrical contacts: V89900000

HANDLE ADAPTER PLATE

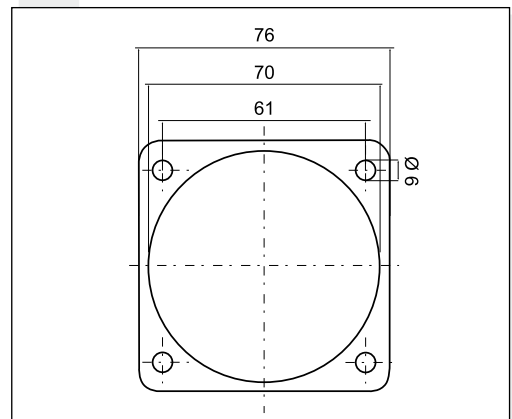

ANALOGUE JOYSTICK CONTROLLERS

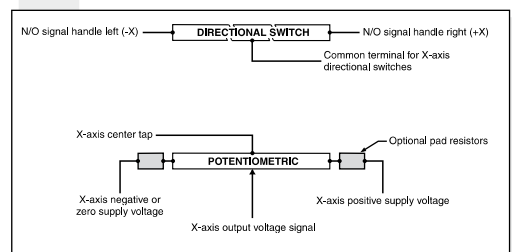

9