



SAE cavity cartridges



MP16M type pressure relief valve - 2 ways

- Pilot operated
- Spool type
- SAE16 cavities

Technical specifications and diagrams are measured with mineral oil of 46 cSt viscosity at 40°C (104°F) temperature.

MP16M

Nominal flow		400 l/min (105.67 US gpm)
Max. pressure		350 bar (5100 psi)
Oil leakage	80% of max. pressure setting	100 cm ³ /min (6.102 in ³ /min)
Fluid		mineral based oil
Viscosity		12-400 cSt
Max level of contamination		20/18/14 ISO4406
Fluid temperature	with NBR seals with FPM seals	from -20°C (-4°F) to 80°C (176°F) from -20°C (-4°F) to 100°C (212°F)
Environmental temp. for working conditions		from -20°C (-4°F) to 50°C (122°F)
Cavity		SAE 16/2
Weight		0.490 kg (1.080 lb)

NOTE - For different conditions, please contact Walvoil Sales Dpt.

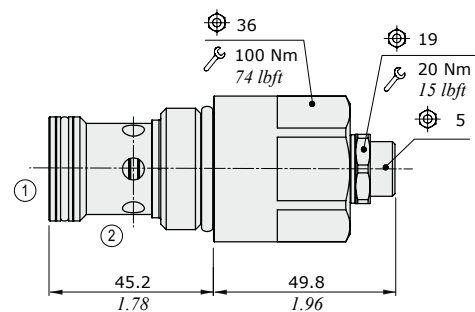
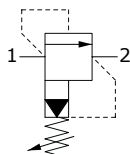

MP16M type

Ordering codes and description composition

MP16M/OY2B

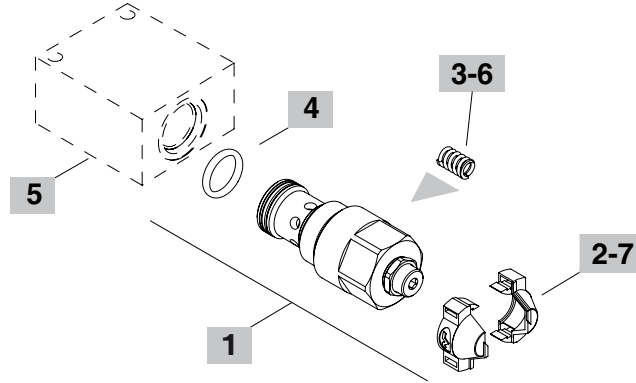
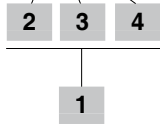

1 Cartridges			5 Valve body		
TYPE	CODE	DESCRIPTION	TYPE	CODE	DESCRIPTION
SAE cavity 16/2			SAE 16/2-G 1		
MP16M/OY1B	OMP16002017	Pressure range 1	3CC1620F210	Steel body for cavity 16 valve, G 1 std thread	
MP16M/OY2B	OMP16002013	Pressure range 2	Note: aluminium body can stand up to 210 bar (3050 psi) For other bodies or different threading see from page 199		
MP16M/OY3B	OMP16002014	Pressure range 3			

2 Adjustments			6 Springs		
TYPE	DESCRIPTION		TYPE	CODE	DESCRIPTION
Y	With screw		1	3ML1081400	Pressure range 1
X	Valve set with antitampering cap (part code: see point 7)		2	3ML1081401	Pressure range 2
			3	3ML1081402	Pressure range 3

3 Pressure range			7 Accessories		
TYPE	DESCRIPTION		TYPE	CODE	DESCRIPTION
1	Pressure range 15÷50 bar (217.5÷725 psi)		-	4COP126300	Antitampering cap (x2)
2	Pressure range 50÷220 bar (725÷3190 psi)				
3	Pressure range 150÷350 bar (2175÷5100 psi)				

4 Seals		
TYPE	DESCRIPTION	
B	NBR (Buna) o-ring seals, std configuration	
V	FPM (Viton) o-ring seals, contact Sales Dept.	

Rating diagrams

MP16M pressure vs. flow (range 1)
Std. setting at 5 l/min (1.32 US gpm)

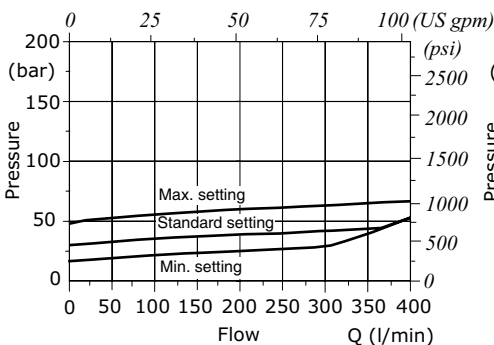

MP16M pressure vs. flow (range 2)
Std. setting at 5 l/min (1.32 US gpm)

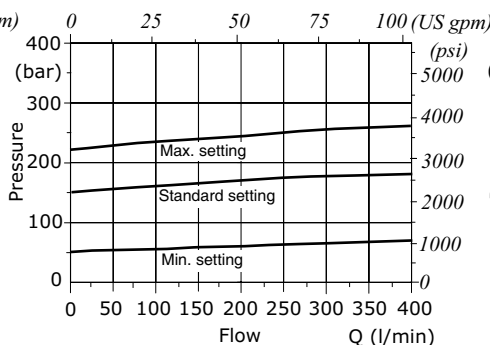

MP16M pressure vs. flow (range 3)
Std. setting at 5 l/min (1.32 US gpm)

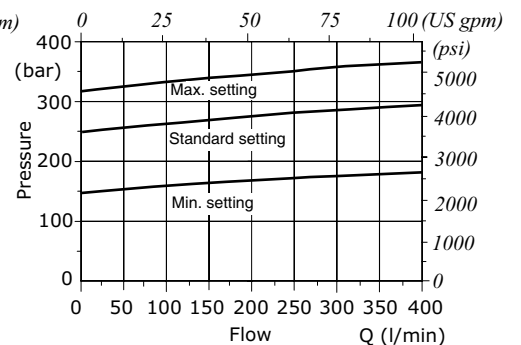

Types and ordering codes

Valve type	Coil	Voltage	Connector					
			ISO4400	Deutsch DT	AMP JPT	Packard Weather-pack	Packard Metri-pack	Flying leads
Directional solenoid valves								
EA08A	BE	12 VDC	4SL1000120	4SL1000123 ⁽⁶⁾ 4SL1000140 ⁽³⁻⁶⁾ 4SL1000124 ⁽²⁾	-	-	-	4SL1000122
		24 VDC	4SL1000240 4SL1030240 ⁽¹⁾	4SL1002401 ⁽⁶⁾	-	-	-	-
		110 VDC	4SL1011100 4SL1031100 ⁽¹⁾	-	-	-	-	-
		220 VDC	4SL1012200 4SL1032200 ⁽¹⁾	-	-	-	-	-
EA08B EW08A EJ08F EJ08G	BT	10 VDC	4SL3000100	-	-	-	-	-
		12 VDC	4SL3000120 4SL3000126 ⁽⁴⁾	4SL3000130 ⁽⁶⁾ 4SL3000134 ⁽³⁻⁶⁾ 4SL3000128 ⁽²⁾	4SL3000122 ⁽⁵⁾ 4SL3001200 ⁽³⁻⁵⁾	4SL3000124 ⁽²⁾	4SL3000127 ⁽²⁾	4SL300012C
		24 VDC	4SL3000240 4SL3030240 ⁽¹⁾	4SL3000249 ⁽⁶⁾ 4SL300024C ⁽³⁻⁶⁾	4SL3000248 ⁽⁵⁾	-	-	4SL3000246
		26 VDC	4SL3000260	-	-	-	-	-
		48 VDC	4SL3000480 4SL3030480 ⁽¹⁾	-	-	-	-	-
		110 VDC	4SL3001100 4SL3031100 ⁽¹⁾	-	-	-	-	-
		220 VDC	4SL3002200 4SL3032200 ⁽¹⁾	-	-	-	-	-
EW10M	BH	12 VDC	4SLD001200	4SLD001201 ⁽⁶⁾	4SLD001202 ⁽⁵⁾	-	-	4SLD001203
		24 VDC	4SLD002400	4SLD002401 ⁽⁶⁾	4SLD002402 ⁽⁵⁾	-	-	4SLD002403
		10 VDC	4SLE001000	-	-	-	-	-
EE08A EC..M EF..M EJ08M ER08M ET08M	BER	12 VDC	4SLE001200 4SLE001217 ⁽³⁾	4SLE001201 ⁽⁵⁾ 4SLE001209 ⁽³⁻⁵⁾ 4SLE001202 ⁽⁶⁾ 4SLE001216 ⁽³⁻⁶⁾ 4SLE001206 ⁽²⁾	4SLE001203 ⁽⁵⁾ 4SLE001211 ⁽³⁻⁵⁾	4SLE001210 ⁽²⁾	4SLE001214 ⁽²⁾	4SLE001207
		24 VDC	4SLE002400 4SLE002408 ⁽³⁾ 4SLE302400 ⁽¹⁾	4SLE002401 ⁽⁵⁾ 4SLE002407 ⁽³⁻⁵⁾ 4SLE002402 ⁽⁶⁾	4SLE002403 ⁽⁵⁾	-	-	4SLE002404
		48 VDC	4SLE004800 4SLE304800 ⁽¹⁾	-	-	-	-	-
		110 VDC	4SLE011000 4SLE311000 ⁽¹⁾	-	-	-	-	-
		220 VDC	4SLE022000 4SLE322000 ⁽¹⁾	-	-	-	-	-
EE10A EW10A EW10B	BIN19	10.5 VDC	4SL6000100	-	-	-	-	-
		12 VDC	4SL6000121	-	-	-	-	-
		24 VDC	4SL6000240	-	-	-	-	-
EE12A EW12A EW12C EJ12A ET12A	BIN22	12 VDC	4SL6000128	-	-	-	-	-
		24 VDC	4SL6000245	-	-	-	-	-
EJ10M EL08A ER10M ET10M	BC	10.5 VDC	4SL8000110	-	-	-	-	-
		12 VDC	4SL8000120	4SL800012B ⁽⁶⁾	4SL8000127 ⁽⁵⁾ 4SL8000130 ⁽⁵⁻³⁾	-	-	4SL800012A
		24 VDC	4SL8000240 4SL8030240 ⁽¹⁾	4SL8000243 ⁽⁶⁾	4SL8000241 ⁽⁵⁾	-	-	4SL8000242
		26 VDC	4SL8000260	-	-	-	-	-
		48 VDC	4SL8030480 ⁽¹⁾	-	-	-	-	-
		110 VDC	4SL8031100 ⁽¹⁾	-	-	-	-	-
EL10C	BQ16	12 VDC	4SL8000121	4SL8000128 ⁽⁵⁾	-	-	4SL8000124 ⁽²⁾	4SL8000125
		24 VDC	4SL8002400	4SL8000245 ⁽⁵⁾	-	-	-	-

Types and ordering codes

Valve type	Coil	Voltage	Connector					Flying leads
			ISO4400	Deutsch DT	AMP JPT	Packard Weather-pack	Packard Metri-pack	
Pressure relief valves - Pressure reducing valves - Flow control pressure compensated valves								
MC08Y MP16Y RD08W RM..W RP..W	MP35	12 VDC	4SL4000120	-	-	-	-	-
		24 VDC	4SL4000240	-	-	-	-	-
MC10X MP..T MP..X PP..X PU..X	BQP19	12 VDC	4SL5000126	4SL5000125 ⁽⁶⁾	4SL5000129 ⁽⁵⁾	-	-	-
		24 VDC	4SL5000245	4SL5000244 ⁽⁶⁾	4SL5000248 ⁽⁵⁾	-	-	-
	BH	12 VDC	4SLD001200	4SLD001201 ⁽⁶⁾	4SLD001202 ⁽⁵⁾	-	-	4SLD001203
		24 VDC	4SLD002400	4SLD002401 ⁽⁶⁾	4SLD002402 ⁽⁵⁾	-	-	4SLD002403
RD08S RD08T	MSM19	12 VDC	4SL5000128	-	-	-	5SL5000122 ⁽²⁾	4SL5000122
		24 VDC	4SL5000247	-	-	-	5SL5000243 ⁽²⁾	4SL5000243
RP08X	BDP19	12 VDC	4SL5000120	-	-	-	-	-
		24 VDC	4SL5000240	-	-	-	-	-
Connettori di accoppiamento (con raddrizzatore vedere tabella seguente)			4CN1009995	5CON140031	5CON003	5CON001	5CON017	-

Notes: ⁽¹⁾ supply with AC and use only with rectifier connector - ⁽²⁾ with flying leads - ⁽³⁾ with bidirectional diode - ⁽⁵⁾ with unidirectional diode - ⁽⁵⁾ integrated perpendicular type - ⁽⁶⁾ integrated parallel type

Voltage	ISO 4400 mating connector with rectifier			
	BT type coil	BE type coil	BER type coil	BC type coil
24 VDC	4CN3010240	4CN1010240	4CN1010240	4CN3010240
48 VDC	4CN3010480	4CN1010480	4CN1010480	4CN3010480
110 VDC	4CN3011100	4CN1011100	4CN1011100	4CN3011100
220 VDC	4CN3012200	4CN1012200	4CN1012200	4CN3012200

Dimensional data and features

BE type

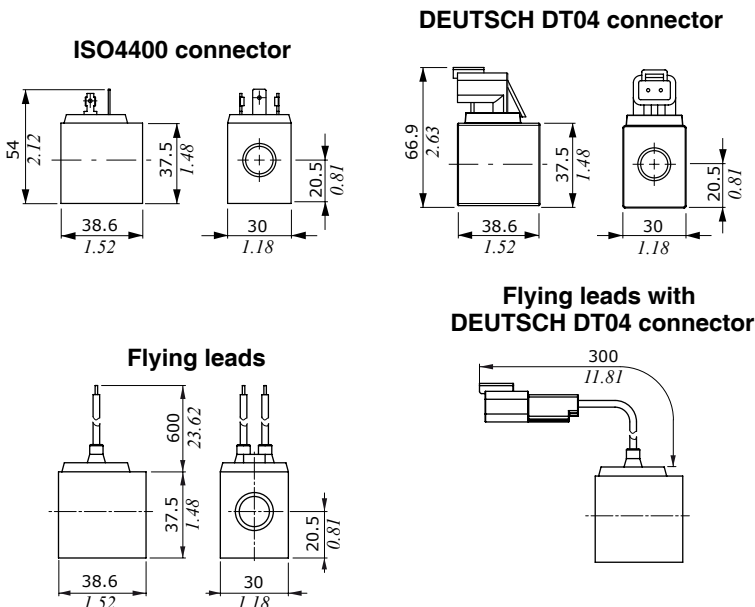

Features

Nominal voltage tolerance : $\pm 10\%$

Power rating : 18.7 W - 12 VDC
: 18.6 W - 24 VDC
: 17.3 W - 110 VDC
: 15.7 W - 220 VDC
: 18.3 W - 24 RAC
: 16 W - 110 RAC
: 16 W - 220 RAC

Max. operating current . . . : 1.56 A - 12 VDC
: 0.77 A - 24 VDC
: 0.157 A - 110 VDC
: 0.08 A - 220 VDC
: 0.85 A - 24 RAC
: 0.16 A - 110 RAC
: 0.08 A - 220 RAC

Coil insulation : Class F (155°C - 311°F)

Weather protection : IP65 - ISO4400
: IP69K - Deutsch DT

Insertion : 100%

Dimensional data and features

BT type

ISO4400 connector

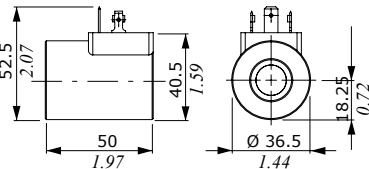

AMP JPT connector

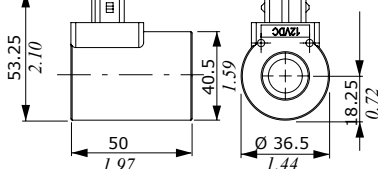

Features

- Nominal voltage tolerance : ±10%
 Power rating : 19 W - 10 VDC
 : 21 W - 12/24/26 VDC
 : 20.3 W - 48 VDC
 : 17.3 W - 110 VDC
 : 17.7 W - 220 VDC
 : 19.9 W - 24 RAC
 : 20.7 W - 48 RAC
 : 20 W - 110 / 220 RAC

Dimension L: Flying leads

- 12 VDC =
247 mm / 9.72 in
 24 VDC =
307 mm / 12.09 in

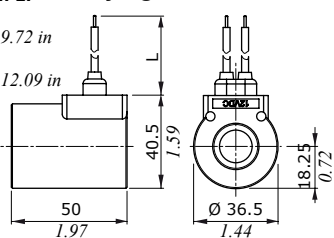

DEUTSCH DT04 connector

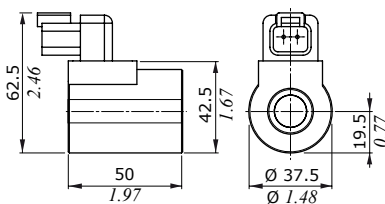

- Max. operating current . . . : 1.9 A - 10 VDC
 : 1.77 A - 12 VDC
 : 0.89 A - 24VDC
 : 0.84 A - 26 VDC
 : 0.43 A - 48 VDC
 : 0.16 A - 110 VDC
 : 0.08 A - 220 VDC
 : 0.93 A - 24 RAC
 : 0.47 A - 48 RAC
 : 0.18 A - 110 RAC
 : 0.09 A - 220 RAC

Flying leads with DEUTSCH DT04 connector

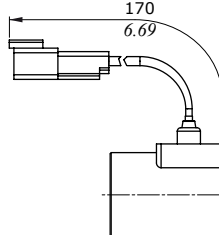

Flying leads with PACKARD WEATHER-PACK connector

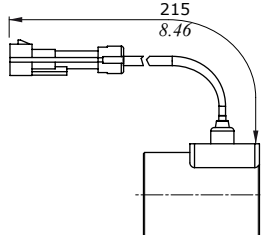

Flying leads with PACKARD METRI-PACK connector

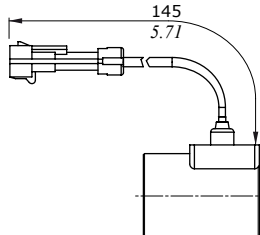

- Coil insulation : Class F (155°C - 311°F)
 Weather protection : IP65 - ISO4400
 : IP69K - Deutsch DT
 : IP65 - AMP JPT
 : IP67 - Weatherpack
 : IP67 - Metri-pack
 Insertion : 100%

BH type

ISO4400 connector

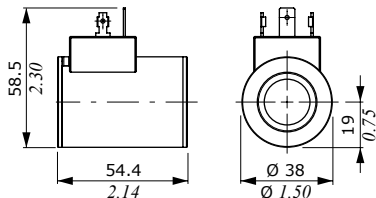

DEUTSCH DT04 connector

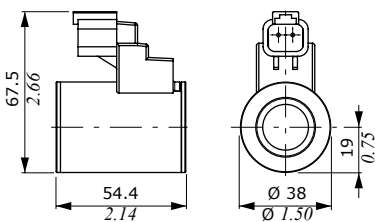

Features

- Nominal voltage tolerance . : ±10%
 Power rating : 33 W - 12/24 VDC
 Max. oper. current (on/off) : 2.75 A - 12 VDC
 : 1.38 A - 24 VDC
 Max. prop. control current : 1.7 A - 12 VDC
 : 0.85 A - 24 VDC
 Coil insulation : Class H
 (180°C - 356°F)
 Weather protection : IP65 - ISO4400
 : IP69K -Deutsch DT
 : IP65 - AMP JPT
 Insertion : 100%

Flying leads

AMP JPT connector

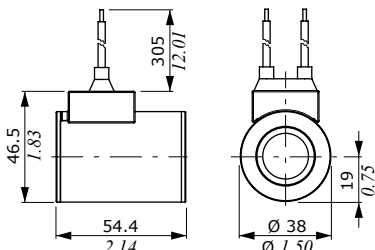
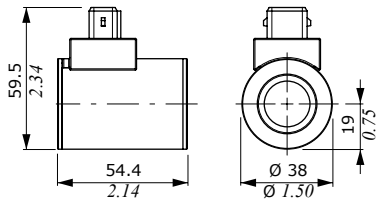

Dimensional data and features

BER type

ISO4400 connector

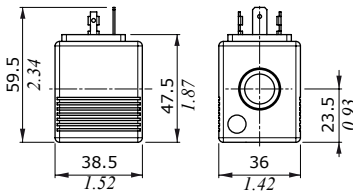

DEUTSCH DT04 connector (perpendicular type)

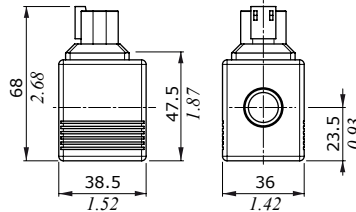

DEUTSCH DT04 connector (parallel type)

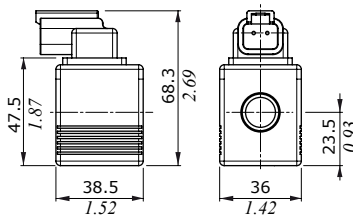

AMP JPT connector

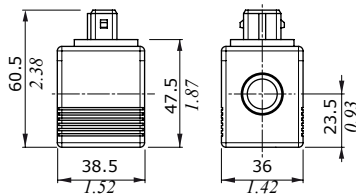

Features

- Nominal voltage tolerance : $\pm 10\%$
- Power rating : 19.2 W - 10/12/24/48/
110/220 VDC
: 19 W - 24/110/220 RAC
: 19.2 W - 48 RAC
- Max. operating current . . . : 1.9 A - 10 VDC
: 1.61 A - 12 VDC
: 0.80 A - 24 VDC
: 0.40 A - 48 VDC
: 0.17 A - 110 VDC
: 0.09 A - 220 VDC
: 0.89 A - 24 RAC
: 0.45 A - 48 RAC
: 0.19 A - 110 RAC
: 0.09 A - 220 RAC
- Coil insulation : Class H (180°C - 356°F)
- Weather protection : IP65 - ISO4400
: IP69K - Deutsch DT
: IP65 - AMP JPT
: IP67 - Weatherpack
: IP67 - Metri-pack
- Insertion : 100%

With flying leads

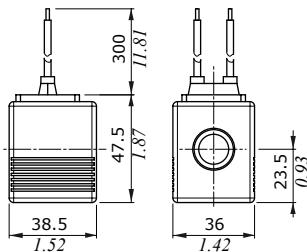

Flying leads with DEUTSCH DT04 connector

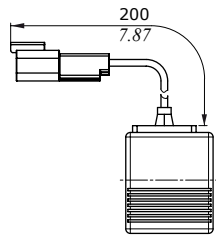

Flying leads with PACKARD WEATHER-PACK connector

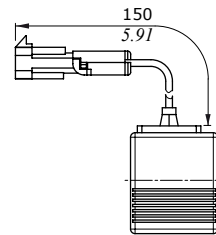

Flying leads with PACKARD METRI-PACK connector

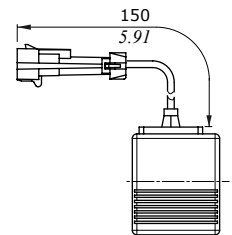

BIN19 type

ISO4400 connector

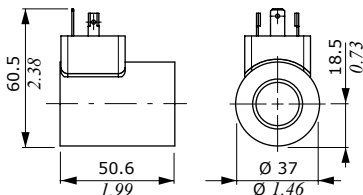

BIN22 type

ISO4400 connector

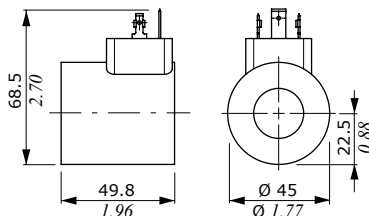

Features

- Nominal voltage tolerance : $\pm 10\%$
- Coil insulation : Class F (155°C - 311°F)
- Weather protection : IP65 - ISO4400
- Insertion : 100%
- BIN19**
- Power rating : 26 W - 10.5 VDC
: 29 W - 12 VDC
: 31 W - 24 VDC
- Max. operating current . . . : 2.48 A - 10.5 VDC
: 2.41 A - 12 VDC
: 1.29 A - 24 VDC
- BIN22**
- Power rating : 32.6 W - 12 VDC
: 31 W - 24 VDC
- Max. operating current . . . : 2.72 A - 12 VDC
: 1.29 A - 24 VDC

Dimensional data and features

BC type

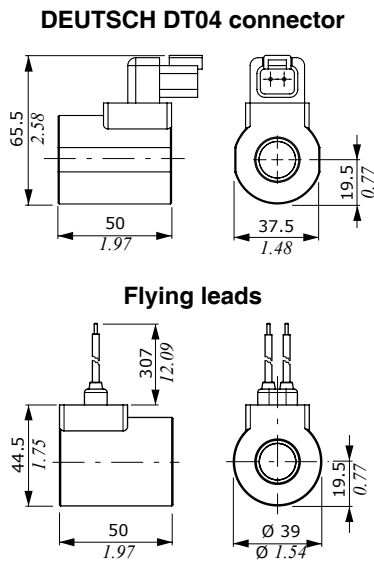
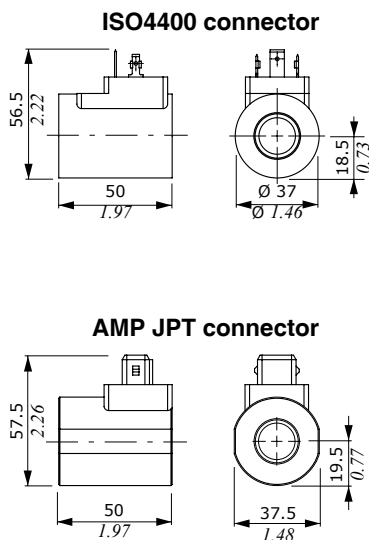

Features

- Nominal voltage tolerance : ±10%
 Power rating : 26.9 W - 10.5 VDC
 : 26.2 W - 12 VDC
 : 25.9 W - 24 VDC
 : 24 W - 26 VDC
 : 26 W - 24/48/110/220 RAC
 Max. operating current . . . : 2.6 A - 10.5 VDC
 : 2.19 A - 12 VDC
 : 1.08 A - 24 VDC
 : 0.92 A - 26 VDC
 : 1.2 A - 24 RAC
 : 0.6 A - 48 RAC
 : 0.3 A - 110 RAC
 : 0.15 A - 220 RAC
 Coil insulation : Class H (180°C - 356°F)
 Weather protection : IP65 - ISO4400
 : IP65 - AMP JPT
 : IP69K - Deutsch DT
 Insertion : 100%

BQ16 type

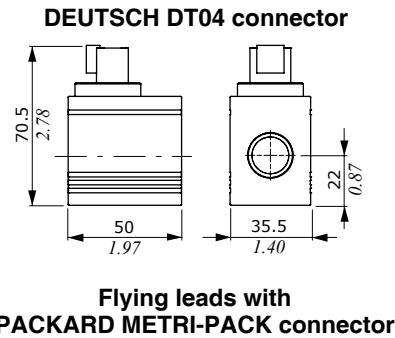
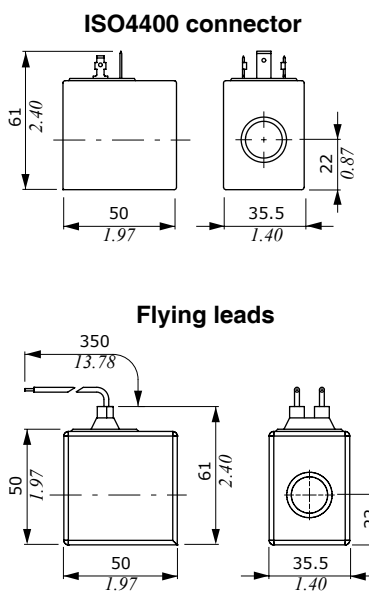

Features

- Nominal voltage tolerance : ±10%
 Power rating : 30 W - 12/24 VDC
 Max. operating current . . . : 2.5 A - 12 VDC
 : 1.25 A - 24 VDC
 Coil insulation : Class H (180°C - 356°F)
 Weather protection : IP65 - ISO4400
 : IP69K - Deutsch DT
 : IP67 - Metri-pack
 Insertion : 100%

MP35 type

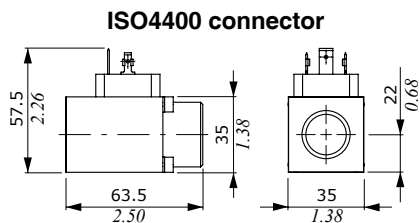

Features

- Nominal voltage tolerance : ±10%
 Power rating : 11.2 W - 12 VDC
 : 11.4 W - 24 VDC
 Max. prop. control current : 1.25 A - 12 VDC
 : 0.68 A - 24 VDC
 Coil insulation : Class F (155°C - 311°F)
 Weather protection : IP65 - ISO4400
 Insertion : 100%

Dimensional data and features

BQP19 type

ISO4400 connector

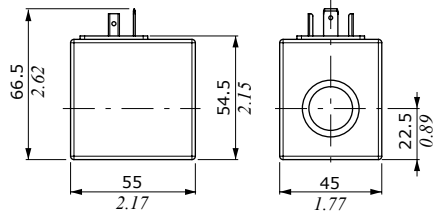

DEUTSCH DT04 connector

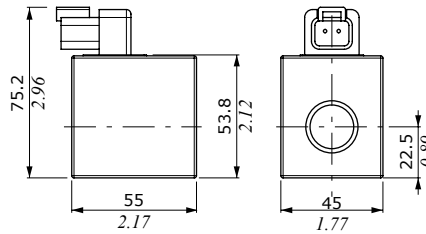

Features

Nominal voltage tolerance : $\pm 10\%$
 Power rating : 15 W - 12/24 VDC
 Max. prop. control current : 1.25 A - 12 VDC
 : 0.63 A - 24 VDC
 Coil insulation : Class H (180°C - 356°F)
 Weather protection : IP65 - ISO4400
 : IP69K - Deutsch DT
 : IP65 - AMP JPT
 Insertion : 100%

AMP JPT connector

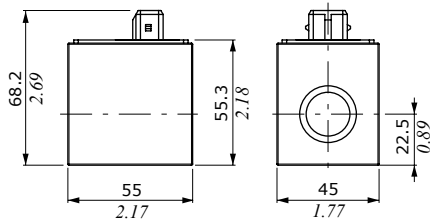

MSM19 type

ISO4400 connector

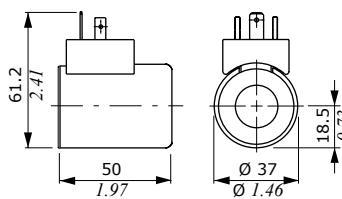

Flying leads

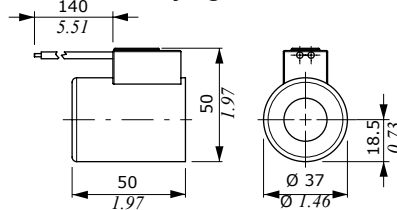

Features

Nominal voltage tolerance : $\pm 10\%$
 Max. prop. control current : 1.8 A - 12 VDC
 : 0.9 A - 24 VDC
 Coil insulation : Class F (155°C - 311°F)
 Weather protection : IP65 - ISO4400
 : IP69K - Deutsch DT
 : IP67 - Metri-Pack
 Insertion : 100%

Flying leads with PACKARD METRI-PACK connector

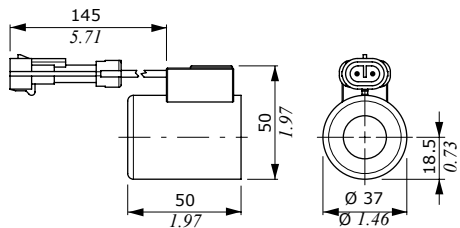

BDP19 type

ISO4400 connector

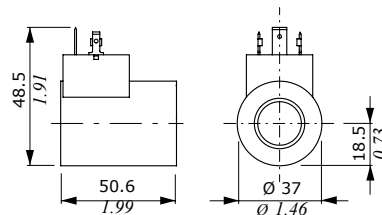

Features

Nominal voltage tolerance : $\pm 10\%$
 Power rating : 13 W - 12 VDC
 : 13.25 W - 24 VDC
 Max. prop. control current : 1.9 A - 12 VDC
 : 0.91 A - 24 VDC
 Coil insulation : Class F (155°C - 311°F)
 Weather protection : IP65 - ISO4400
 Insertion : 100%

Adjustments

Types and dimensions

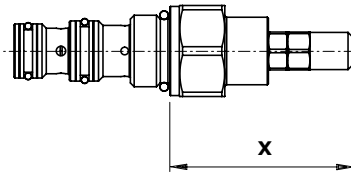

Valve type	Cavity	Dimension "X"					
		M Handknob		S screw		V handwheel	
		mm	in	mm	in	mm	in
MC..A	08/2	-	-	53.5	2.11	77	3.03
	10/2	-	-	94.5	3.72	118	4.65
	12/2	-	-	126.5	4.98	150	5.91
MG..A	10/2	-	-	94.5	3.72	118	4.65
	12/2	-	-	126.5	4.98	150	5.91
MP..A	10/2	-	-	54.5	2.15	77.5	3.05
	12/2	-	-	52.5	2.07	75.5	2.97
RB..A	08/3	-	-	79.5	3.13	103	4.05
	10/3	-	-	94.5	3.72	118	4.65
RD..A	08/3	-	-	79.5	3.13	103	4.05
	10/3	-	-	94.5	3.72	118	4.65
	10/3	-	-	54.5	2.15	66	2.60
RM..A	12/3	-	-	51.5	2.03	63	2.48
	16/3	-	-	50.5	1.99	62	2.44
RP..A	10/3	-	-	54.5	2.15	66	2.60
	12/3	-	-	51.5	2.03	63	2.48
	16/3	-	-	50.5	1.99	62	2.44
	08/2	52	2.05	49.5	1.95	-	-
NB..A	10/2	48	1.89	46.5	1.83	-	-
	12/2	49.2	1.94	46.3	1.82	-	-
	16/2	68.8	2.71	-	-	-	-

Valve type	Cavity	Dimension "X"					
		M Handknob		S screw		V handwheel	
		mm	in	mm	in	mm	in
NT..A	08/2	67.5	2.66	64.5	2.54	-	-
	10/2	68	2.68	65	2.56	-	-
	12/2	69	2.72	66	2.60	-	-
	16/2	68.9	2.71	-	-	-	-
NU..A	08/2	66.5	2.62	64.5	2.54	-	-
	10/2	68	2.68	65	2.56	-	-
	12/2	69	2.72	66	2.60	-	-
	16/2	66.9	2.63	-	-	-	-
PU..A	08/2	49.5	1.95	46.5	1.83	-	-
	10/2	44	1.73	41	1.61	-	-
	12/2	45	1.77	42	1.65	-	-
	16/2	52	2.05	49	1.93	-	-
PW..A	08/2	64.5	2.54	62	2.44	-	-
	10/2	71.9	2.83	69.4	2.73	-	-
	12/2	64.5	2.54	62	2.44	-	-
	16/2	68	2.68	65.5	2.58	-	-
PP..A	08/3	49.5	1.95	46.5	1.83	-	-
	10/3	44	1.73	41	1.61	-	-
	12/3	45	1.77	42	1.65	-	-
	16/3	52	2.05	49	1.93	-	-

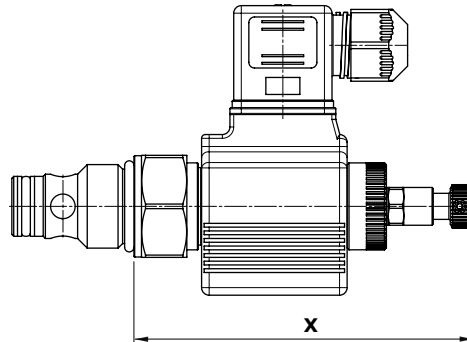

Valve type	Dimension "X"															
	N / O without emergency		T screw type		P push button		D push type with detent		F pull button		Q pull type with detent		E with pull/ push-button		V handknob	
	mm	in	mm	in	mm	in	mm	in	mm	in	mm	in	mm	in	mm	in
MC10X	86	3.39	105	4.13	-	-	-	-	-	-	-	-	-	-	-	-
MC10X-HF	94.8	3.73	94.5	3.72	-	-	-	-	-	-	-	-	-	-	-	-
MP10X	86	3.39	105	4.13	-	-	-	-	-	-	-	-	-	-	-	-
MP12X	102	4.02	121	4.76	-	-	-	-	-	-	-	-	-	-	-	-
PU08X	94	3.70	108	4.25	-	-	-	-	-	-	-	-	-	-	142	5.59
PU10X	96.4	3.79	110.4	4.35	-	-	-	-	-	-	-	-	-	-	144.4	5.68
PU12X	97.4	3.83	111.4	4.50	-	-	-	-	-	-	-	-	-	-	145.4	5.72
PU16X	121.4	4.78	135.4	5.33	-	-	-	-	-	-	-	-	-	-	169.4	6.67
PP08X	94	3.70	108	4.25	-	-	-	-	-	-	-	-	-	-	142	5.59
PP10X	96.4	3.79	110.4	4.35	-	-	-	-	-	-	-	-	-	-	144.1	5.67
PP12X	97.4	3.83	111.4	4.39	-	-	-	-	-	-	-	-	-	-	145.1	5.71
PP16X	121.4	4.78	135.4	5.33	-	-	-	-	-	-	-	-	-	-	169.4	6.67
EA08A	NO	60	2.36	79.3	3.12	-	-	-	-	-	-	-	-	-	-	-
	NC	59	2.32	79	3.11	-	-	-	-	-	-	-	-	-	-	-
EA08B	NO	70.9	2.79	90.3	3.55	-	-	-	-	-	-	-	-	-	-	-
	NC	65.5	2.58	90.5	3.56	-	-	-	-	-	-	-	-	-	-	-
EC08M	NO	67.2	2.64	90.1	3.55	90.1	3.55	92.8	3.65	-	-	-	-	-	-	-
EF08M	NC	63.3	2.49	77.8	3.06	-	-	-	-	91.3	3.59	83.8	3.30	-	-	-
EH08M	NC	63.3	2.49	77.8	3.06	-	-	-	-	91.3	3.59	83.8	3.30	-	-	-
EC10M	NO	66.9	2.63	89.8	3.54	89.8	3.54	92.5	3.64	-	-	-	-	-	-	-
EF10M	NC	63	2.48	77.5	3.05	-	-	-	-	91	3.58	83.5	3.29	-	-	-
EH10M	NC	63	2.48	77.5	3.05	-	-	-	-	91	3.58	83.5	3.29	-	-	-
EC12M	NO	61.1	2.40	84	3.31	84	3.31	86.8	3.42	-	-	-	-	-	-	-
EF12M	NC	57.2	2.25	71.7	-	-	-	-	-	85.2	3.35	77.7	3.06	-	-	-
EH12M	NC	57.2	2.25	71.7	-	-	-	-	-	85.2	3.35	77.7	3.06	-	-	-
EC16M	NO	61.2	2.41	84.1	3.31	84.1	3.31	86.9	3.42	-	-	-	-	-	-	-
EF16M	NC	57.3	2.26	71.8	-	-	-	-	-	85.3	3.36	77.8	3.06	-	-	-
EH16M	NC	57.3	2.26	71.8	-	-	-	-	-	85.3	3.36	77.8	3.06	-	-	-

Types and dimensions

Valve type		Dimension "X"															
		N / O without emergency		T screw type		P push button		D push type with detent		F pull button		Q pull type with detent		E with pull/ push-button		V handknob	
		mm	in	mm	in	mm	in	mm	in	mm	in	mm	in	mm	in	mm	in
EW08A	NO	65.7	2.59	73.5	2.89	-	-	-	-	-	-	-	-	-	-	-	-
	NC	70.9	2.79	90.3	3.56	87.2	3.43	-	-	-	-	-	-	-	-	-	-
EW10A	NC	-	-	-	-	83.3	3.28	-	-	-	-	-	-	-	-	-	-
EW10B	NO	99.8	3.93	-	-	-	-	-	-	-	-	-	-	-	-	-	-
EW12B	NO	102.8	4.05	-	-	-	-	-	-	-	-	-	-	-	-	-	-
EW12C	NC	-	-	-	-	98.7	3.89	-	-	-	-	-	-	-	-	-	-
EW08M	NO	60.1	2.37	77	3.03	-	-	-	-	88.1	3.47	81	3.19	-	-	-	-
	NC	62.5	2.46	85.4	3.36	85.4	3.36	88.1	3.47	-	-	-	-	-	-	-	-
EW10M	NC	81.3	3.20	95.3	3.75	104.2	4.10	106.3	4.19	-	-	-	-	-	-	-	-
EJ08F		65.7	2.59	73.5	2.89	-	-	-	-	-	-	-	-	-	-	-	-
EJ08G		65.7	2.59	73.5	2.89	-	-	-	-	-	-	-	-	-	-	-	-
EJ08M		56.1	2.21	70.6	2.78	-	-	-	-	84.1	3.31	77	3.03	-	-	-	-
EJ10M		68	2.68	82.5	3.25	-	-	-	-	96	3.78	88.9	3.50	-	-	-	-
EL08A		94.9	3.74	-	-	96	3.78	-	-	-	-	-	-	-	-	-	-
EL10C		86.7	3.41	-	-	-	-	-	-	-	-	-	-	-	-	-	-
ER08M		75	2.95	100	3.94	-	-	-	-	115.5	4.55	95.8	3.77	-	-	-	-
ER10M		89	3.50	110.5	4.35	-	-	-	-	129.5	5.10	110	4.33	-	-	-	-
ET08M		120	4.72	-	-	121	4.76	165	6.50	-	-	-	-	165.6	6.52	-	-
ET10M		148.5	5.85	-	-	149.5	5.89	190.9	7.52	-	-	-	-	191.5	7.54	-	-
ET12A		156	6.14	-	-	156	6.14	-	-	-	-	-	-	-	-	-	-

Dimensions and ordering codes

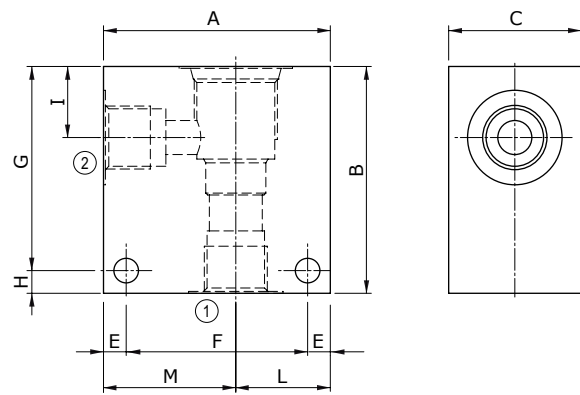
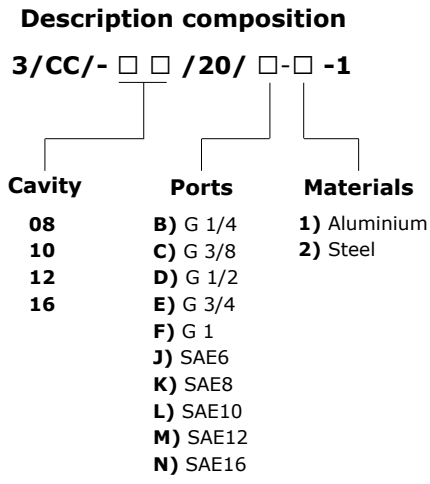

Material	Max. pressure	
	bar	psi
Aluminium	210	3050
Steel	350	5100

Cavity	Ports	Dimensions											Ordering code		
		A	B	C	E	F	G	H	I	L	M	Z	Aluminium	Steel	
SAE 08/2	G 1/4	mm	50	50	30	6	38	44	6	14.8	20	30	6.5	3CC0820B11	3CC0820B21
		in	1.97	1.97	1.18	0.24	1.50	1.73	0.24	0.58	0.79	1.18	0.26		
	G 3/8	mm	50	50	30	6	38	44	6	14.8	20	30	6.5	3CC0820C11	3CC0820C21
		in	1.97	1.97	1.18	0.24	1.50	1.73	0.24	0.58	0.79	1.18	0.26		
	G 1/2	mm	60	60	35	6	48	54	6	18	25	35	6.5	3CC0820D11	/
		in	2.36	2.36	1.38	0.24	1.89	2.16	0.24	0.71	0.98	1.38	0.26		
SAE6	mm	50	50	30	6	38	44	6	14.8	20	30	6.5	3CC0820J11	3CC0820J21	
	in	1.97	1.97	1.18	0.24	1.50	1.73	0.24	0.58	0.79	1.18	0.25			
SAE8	mm	60	60	30	6	48	54	6	14	25	35	6.5	3CC0820K11	3CC0820K21	
	in	2.36	2.36	1.18	0.24	1.89	2.16	0.24	0.55	0.98	1.38	0.25			
SAE 10/2	G 1/4	mm	60	60	35	6	48	54	6	18.8	25	35	6.5	3CC1020B11	3CC1020B21
		in	2.36	2.36	1.38	0.24	1.89	2.12	0.24	0.74	0.98	1.38	0.26		
	G 3/8	mm	60	60	35	6	48	54	6	18.8	25	35	6.5	3CC1020C11	3CC1020C21
		in	2.36	2.36	1.38	0.24	1.89	2.12	0.24	0.74	0.98	1.38	0.26		
	G 1/2	mm	60	60	35	6	48	54	6	18.8	25	35	6.5	3CC1020D11	3CC1020D21
		in	2.36	2.36	1.38	0.24	1.89	2.12	0.24	0.74	0.98	1.38	0.26		
	SAE8	mm	60	70	35	6	48	64	6	18.8	25	35	6.5	3CC1020J11	3CC1020J21
		in	2.36	2.75	1.38	0.24	1.89	2.52	0.24	0.74	0.98	1.38	0.26		
	SAE10	mm	70	70	35	6	58	64	6	18.5	35	35	6.5	3CC1020K11	3CC1020K21
		in	2.75	2.75	1.38	0.24	2.28	2.52	0.24	0.73	1.38	1.38	0.26		
	SAE12	mm	70	70	40	8	54	62	8	22	30	40	8.5	3CC1020L11	3CC1020L21
		in	2.75	2.75	1.57	0.31	2.12	2.44	0.31	0.87	1.18	1.57	0.33		

Dimensions and ordering codes

Cavity	Ports	Dimensions											Ordering code		
		A	B	C	E	F	G	H	I	L	M	Z	Aluminium	Steel	
SAE 12/2	G 1/2	mm	70	80	40	8	54	72	8	25	30	40	8.5	3CC1220D11	3CC1220D21
		in	2.75	3.15	1.57	0.31	2.12	2.83	0.31	0.98	1.18	1.57	0.33		
	G 3/4	mm	70	90	40	8	54	82	8	25	30	40	8.5	3CC1220E11	3CC1220E21
		in	2.75	3.54	1.57	0.31	2.12	3.23	0.31	0.98	1.18	1.57	0.33		
	SAE10	mm	70	85	40	8	54	77	8	25	30	40	8.5	3CC1220L11	3CC1220L21
		in	2.75	3.35	1.57	0.31	2.12	3.03	0.31	0.98	1.18	1.57	0.33		
	SAE12	mm	70	85	40	8	54	77	8	25	30	40	8.5	3CC1220M11	3CC1220M21
		in	2.75	3.35	1.57	0.31	2.12	3.03	0.31	0.98	1.18	1.57	0.33		
SAE 16/2	G 1/2	mm	80	90	50	10	60	80	10	25	35	45	10.5	3CC1620D11	3CC1620D21
		in	3.15	3.54	1.97	0.39	2.36	3.15	0.39	0.98	1.38	1.77	0.41		
	G 3/4	mm	80	90	50	10	60	80	10	25	35	45	10.5	3CC1620E11	3CC1620E21
		in	3.15	3.54	1.97	0.39	2.36	3.15	0.39	0.98	1.38	1.77	0.41		
	G 1	mm	85	100	60	10	65	90	10	23.5	40	45	10.5	3CC1620F11	3CC1620F210
		in	3.35	3.94	2.36	0.39	2.56	3.54	0.39	0.92	1.57	1.77	0.41		
	SAE12	mm	80	90	50	10	60	80	10	25	35	45	10.5	3CC1620M11	3CC1620M21
		in	3.15	3.54	1.97	0.39	2.36	3.15	0.39	0.98	1.38	1.77	0.41		
	SAE16	mm	80	100	50	10	60	90	10	25	35	45	10.5	3CC1620N11	3CC1620N21
		in	3.15	3.94	1.97	0.39	2.36	3.54	0.39	0.98	1.38	1.77	0.41		

Dimensions and ordering codes

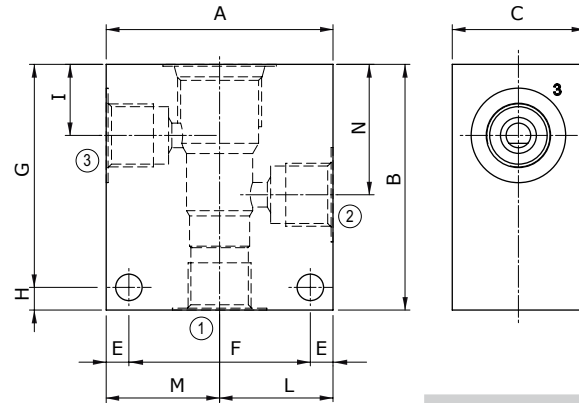
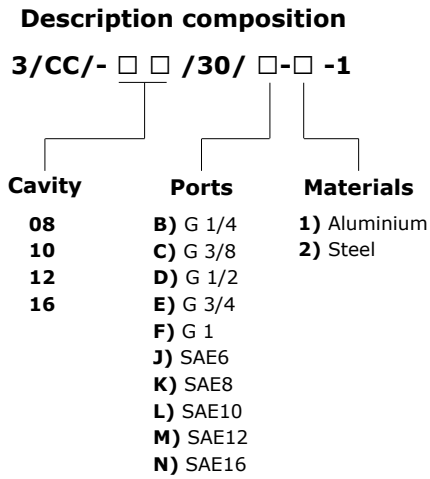

Material	Max. pressure	
	bar	psi
Aluminium	210	3050
Steel	350	5100

Cavity	Ports	Dimensions												Ordering code			
		A	B	C	E	F	G	H	I	L	M	N	Z	Aluminium	Steel		
SAE 8/3	G 1/4	mm	60	60	30	7	46	48	12	14.8	30	30	29.1	6.5	3CC0830B11	3CC0830B21	
		in	2.36	2.36	1.18	0.27	1.81	1.89	0.47	0.58	1.18	1.18	1.14	0.25			
	G 3/8	mm	60	60	30	7	46	48	12	14.5	30	30	29.1	6.5	3CC0830C11	3CC0830C21	
		in	2.36	2.36	1.18	0.27	1.81	1.89	0.47	0.57	1.18	1.18	1.14	0.25			
	G 1/2	mm	70	65	35	7	56	53	12	14.5	35	35	29.1	6.5	3CC0830D11	/	
		in	2.75	2.56	1.38	0.27	2.20	2.09	0.47	0.57	1.38	1.38	1.14	0.25			
	SAE6	mm	60	60	30	7	46	48	12	14.5	30	30	29.1	6.5	3CC0830J11	3CC0830J21	
		in	2.36	2.36	1.18	0.27	1.81	1.89	0.47	0.57	1.18	1.18	1.14	0.25			
	SAE8	mm	60	60	30	7	46	48	12	15	30	30	29	6.5	3CC0830K11	3CC0830K11	
		in	2.36	2.36	1.18	0.27	1.81	1.89	0.47	0.59	1.18	1.18	1.14	0.25			
	SAE 10/3	G 1/4	mm	60	65	35	6	48	59	6	18	30	30	34.5	7	3CC1030B11	3CC1030B21
			in	2.36	2.56	1.38	0.24	1.89	2.32	0.24	0.70	1.18	1.18	1.36	0.27		
G 3/8		mm	60	65	35	6	48	59	6	18.8	30	30	34.5	7	3CC1030C11	3CC1030C21	
		in	2.36	2.56	1.38	0.24	1.89	2.32	0.24	0.74	1.18	1.18	1.36	0.27			
G 1/2		mm	65	70	35	6	53	64	6	18.8	32.5	32.5	34.5	7	3CC1030D11	3CC1030D21	
		in	2.56	2.75	1.38	0.24	2.09	2.52	0.24	0.74	1.28	1.28	1.36	0.27			
SAE6		mm	65	70	35	6	53	64	6	18.8	32.5	32.5	34.5	7	3CC1030J11	3CC1030J21	
		in	2.56	2.75	1.38	0.24	2.09	2.52	0.24	0.74	1.28	1.28	1.36	0.27			
SAE8		mm	65	70	35	6	53	64	6	18.8	32.5	32.5	34.5	7	3CC1030K11	3CC1030K21	
		in	2.56	2.75	1.38	0.24	2.09	2.52	0.24	0.74	1.28	1.28	1.36	0.27			
SAE10		mm	65	70	35	6	53	64	6	18	31.5	33.5	34.5	7	3CC1030L11	3CC1030L21	
		in	2.56	2.75	1.38	0.24	2.09	2.52	0.24	0.70	1.24	1.32	1.36	0.27			

Dimensions and ordering codes

Cavity	Ports	Dimensions													Ordering code	
		A	B	C	E	F	G	H	I	L	M	N	Z	Aluminium	Steel	
SAE 12/3	G 1/2	mm	70	100	40	8	54	92	8	25	35	35	53.5	8.5	3CC1230D11	3CC1230D21
		in	2.75	3.94	1.57	0.31	2.12	3.6	0.31	0.98	1.38	1.38	2.10	0.33		
	G 3/4	mm	90	100	50	10	70	90	10	25.1	45	45	53.5	10.5	3CC1230E11	3CC1230E21
		in	3.54	3.94	1.97	0.39	2.75	3.54	0.39	0.99	1.77	1.77	2.11	0.41		
	SAE10	mm	80	100	40	8	64	92	8	25	40	40	53.5	8.5	3CC1230L11	3CC1230L21
		in	3.15	3.94	1.57	0.31	2.52	3.6	0.31	0.98	1.57	1.57	2.11	0.33		
	SAE12	mm	80	100	45	8	64	92	8	25	40	40	53.5	8.5	3CC1230M11	3CC1230M21
		in	3.15	3.94	1.77	0.31	2.52	3.6	0.31	0.98	1.57	1.57	2.11	0.33		
SAE16/3	G 1/2	mm	90	100	50	10	70	90	10	25	45	45	53.5	10.5	3CC1630D11	3CC1630D21
		in	3.54	3.94	1.97	0.39	2.75	3.54	0.39	0.98	1.77	1.77	2.11	0.41		
	G 3/4	mm	90	100	50	10	70	90	10	25.1	45	45	53.5	10.5	3CC1630E11	3CC1630E21
		in	3.54	3.94	1.97	0.39	2.75	3.54	0.39	0.99	1.77	1.77	2.11	0.41		
	G 1	mm	90	105	50	10	70	95	10	25	46	44	53.5	10.5	3CC1630F11	3CC1630F21
		in	3.54	4.13	1.97	0.39	2.75	3.74	0.39	0.98	1.81	1.73	2.11	0.41		
	SAE12	mm	90	105	50	10	70	95	10	25.1	45	45	53.5	10.5	3CC1630M11	3CC1630M21
		in	3.54	4.13	1.97	0.39	2.75	3.74	0.39	0.99	1.77	1.77	2.11	0.41		
	SAE16	mm	90	105	50	10	70	95	10	25.1	45	45	53.5	10.5	3CC1630N11	3CC1630N21
		in	3.54	4.13	1.97	0.39	2.75	3.74	0.39	0.99	1.77	1.77	2.11	0.41		

Dimensions and ordering codes

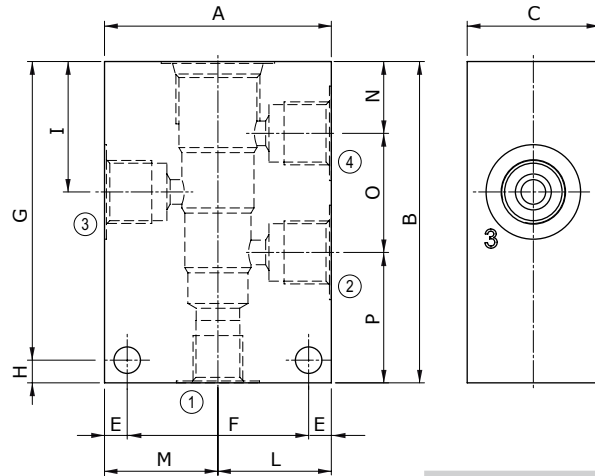
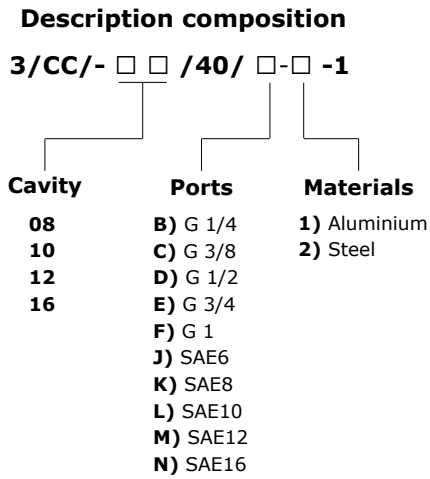

Material	Max. pressure	
	bar	psi
Aluminium	210	3050
Steel	350	5100

Cavity	Ports	Dimensions														Ordering code		
		A	B	C	E	F	G	H	I	L	M	N	O	P	Z	Aluminium	Steel	
SAE 8/4	G 1/4	mm	60	75	30	7	46	63	12	29.1	30	30	14.8	29.1	31.1	6.5	3CC0840B11	3CC0840B21
		in	2.36	2.95	1.18	0.27	1.81	2.48	0.47	1.14	1.18	1.18	0.58	1.14	1.22	0.25		
	G 3/8	mm	60	75	30	7	46	63	12	29.1	30	30	14.8	28.6	31.6	6.5	3CC0840C11	3CC0840C21
		in	2.36	2.95	1.18	0.27	1.81	2.48	0.47	1.14	1.18	1.18	0.58	1.13	1.24	0.25		
	SAE6	mm	60	75	30	7	46	63	12	29.1	30	30	14.8	29.1	31.1	6.5	3CC0840J11	3CC0840J21
		in	2.36	2.95	1.18	0.27	1.81	2.48	0.47	1.14	1.18	1.18	0.58	1.14	1.22	0.25		
	SAE8	mm	60	75	30	7	46	63	12	29	30	30	15	28.5	31.5	6.5	3CC0840K11	3CC0840K21
		in	2.36	2.95	1.18	0.27	1.81	2.48	0.47	1.14	1.18	1.18	0.59	1.12	1.24	0.25		
SAE 10/4	G 1/4	mm	60	85	35	6	48	79	6	34.5	30	30	19	31.5	34.5	7	3CC1040B11	3CC1040B21
		in	2.36	3.35	1.38	0.24	1.89	3.11	0.24	1.36	1.18	1.18	0.75	1.24	1.36	0.27		
	G 3/8	mm	60	85	35	6	48	79	6	34.5	30	30	18.8	31.7	34.5	7	3CC1040C11	3CC1040C21
		in	2.36	3.35	1.38	0.24	1.89	3.11	0.24	1.36	1.18	1.18	0.74	1.25	1.36	0.27		
	G 1/2	mm	70	85	35	6	58	79	6	34.5	35	35	18.8	31.7	34.5	7	3CC1040D11	3CC1040D21
		in	2.75	3.35	1.38	0.24	2.28	3.11	0.24	1.36	1.38	1.38	0.74	1.25	1.36	0.27		
	SAE6	mm	60	85	35	6	48	79	6	34.5	30	30	18.8	31.7	34.5	7	3CC1040J11	3CC1040J21
		in	2.36	3.35	1.38	0.24	1.89	3.11	0.24	1.36	1.18	1.18	0.74	1.25	1.36	0.27		
	SAE8	mm	70	85	35	6	58	79	6	34.5	35	35	18.8	31.7	34.5	7	3CC1040K11	3CC1040K21
		in	2.75	3.35	1.38	0.24	2.28	3.11	0.24	1.36	1.38	1.38	0.74	1.25	1.36	0.27		
SAE10	mm	70	85	35	6	58	79	6	34.5	35	35	19	31.5	34.5	7	3CC1040L11	3CC1040L11	
	in	2.75	3.35	1.38	0.24	2.28	3.11	0.24	1.36	1.38	1.38	0.75	1.24	1.36	0.27			

Dimensions and ordering codes

Cavity	Ports	Dimensions														Ordering code		
		A	B	C	E	F	G	H	I	L	M	N	O	P	Z	Aluminium	Steel	
SAE 12/4	G 3/8	mm	80	115	40	8	64	107	8	44	40	40	22	44.5	48.5	8.5	3CC1240C11	3CC1240C21
		in	3.15	4.53	1.57	0.31	2.52	4.21	0.31	1.73	1.57	1.57	0.87	1.75	1.9	0.33		
	G 1/2	mm	80	115	40	8	64	107	8	44	40	40	22	44.5	48.5	8.5	3CC1240D11	3CC1240D21
		in	3.15	4.53	1.57	0.31	2.52	4.21	0.31	1.73	1.57	1.57	0.87	1.75	1.9	0.33		
	SAE10	mm	80	115	40	8	64	107	8	44	40	40	22	44.5	48.5	8.5	3CC1240L11	3CC1240L21
		in	3.15	4.53	1.57	0.31	2.52	4.21	0.31	1.73	1.57	1.57	0.87	1.75	1.9	0.33		
SAE 16/4	G 3/4	mm	100	130	50	10	80	120	10	53.5	50	50	25.1	56.9	48	10.5	3CC1640E11	3CC1640E21
		in	3.94	5.12	1.97	0.39	3.15	4.72	0.39	2.11	1.97	1.97	0.99	2.24	1.89	0.41		
	SAE16	mm	100	130	50	10	80	120	10	53.5	50	50	25.1	56.9	48	10.5	3CC1640N11	3CC1640N21
		in	3.94	5.12	1.97	0.39	3.15	4.72	0.39	2.11	1.97	1.97	0.99	2.24	1.89	0.41		

How to order valves with body

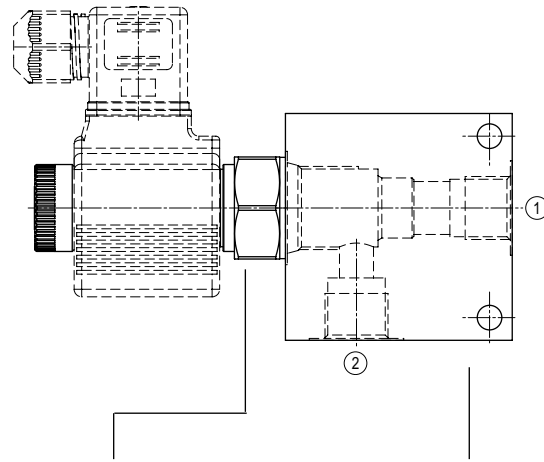

Cartridge description

Body description

EC 10 M/10NB

C 1 1

Cavity

- 08
- 10
- 12
- 16

Ports

- B) G 1/4
- C) G 3/8
- D) G 1/2
- E) G 3/4
- F) G 1
- J) SAE6
- K) SAE8
- L) SAE10
- M) SAE12
- N) SAE16

Materials

- 1) Aluminium
- 2) Steel

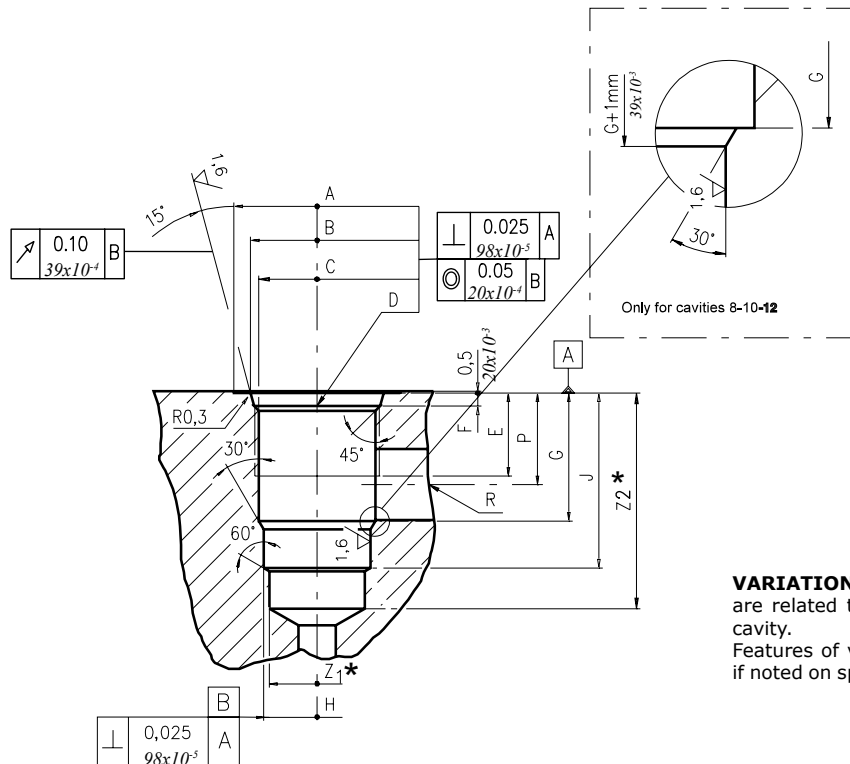

VARIATION "A": the dimensions with "*" are related to the variation "A" of 2 ways cavity. Features of variation "A" are required only if noted on specific product catalogue page.

Cavity	A	B ±0.05	C ±0.05	D	E	F	G	H ±0.02	J	K ±0.02	L	M ±0.02	N	P	R ØMAX	S	T ØMAX	U	V ØMAX	X ØMAX	Z1* ØMIN	Z2* MIN
08/2	mm 27	20.66	17.42	3/4-16 UNF	12.50	2.50	18.20	12.72	29.50	-	-	-	-	14.00	8.00	-	-	-	-	-	12.00	39
08/2 A	in 1.06	0.81	0.68		0.49	0.10	0.72	0.50	1.16	-	-	-	-	0.55	0.31	-	-	-	-	-	0.47	1.53
10/2	mm 30	24.00	20.62	7/8-14 UNF	16.00	2.80	24.00	15.90	33.50	-	-	-	-	18.30	11.00	-	-	-	-	-	14.50	40
10/2 A	in 1.18	0.94	0.81		0.63	0.11	0.94	0.62	1.32	-	-	-	-	0.72	0.43	-	-	-	-	-	0.57	1.57
12/2	mm 38	29.23	24.73	1 1/16-12 UNF	19.00	3.50	34.15	22.25	46.80	-	-	-	-	24.50	19.00	-	-	-	-	-	21.50	60
12/2 A	in 1.50	1.15	0.97		0.75	0.14	1.34	0.87	1.84	-	-	-	-	0.96	0.75	-	-	-	-	-	0.85	2.36
16/2	mm 45	35.60	31.34	1 5/16-12 UNF	22.00	3.50	34.00	28.62	47.00	-	-	-	-	24.50	19.00	-	-	-	-	-	25.50	70
16/2 A	in 1.77	1.40	1.23		0.87	0.14	1.34	1.13	1.85	-	-	-	-	0.96	0.75	-	-	-	-	-	1.00	2.75

Rougher tool

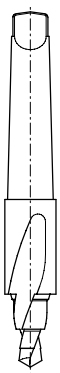

Cavity	Code number
08/2	3UT00053190
10/2	3UT00056610
12/2	3UT00054090
16/2	3UT00054510

Finisher tool



Cavity	Code number
08/2	3UT06A1270N
10/2	3UT00054580
12/2	3UT00054670
16/2	3UT00054520

Tap



Cavity	Code number
08/2	3UT03416UNF
10/2	3UT07814UNF
12/2	3UT0111612UN
16/2	3UT0151612UN

Cavity plugs

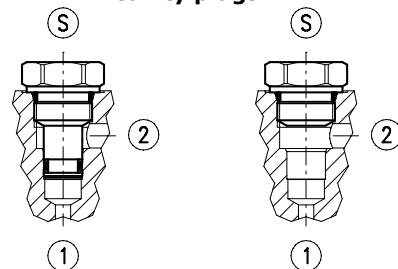

Cavity	Code number	①	②	Ⓢ
08/2	3XTP3533700	X	X	X
	3XTP1531900	0	0	X
10/2	3XTP3544200	X	X	X
	3XTP1542300	0	0	X
12/2	3XTP3555400	X	X	X
	3XTP1552900	0	0	X
16/2	3XTP3575500	X	X	X
	3XTP1572900	0	0	X

X=Closed 0=Open

Dimensions

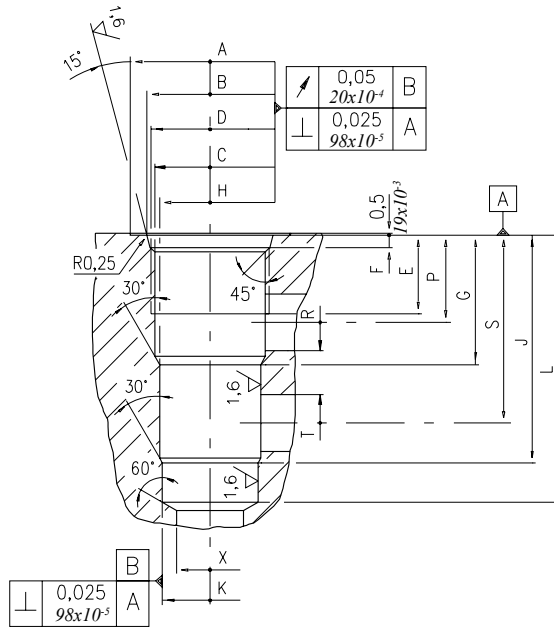

Cavity	A	B ±0,05	C ±0,05	D	E	F	G	H ±0,02	J	K ±0,02	L	M ±0,02	N	P	R øMAX	S	T øMAX	U øMAX	V øMAX	X øMAX	
08/3	mm	27	20,66	17,42	3/4 -16 UNF	12,50	2,50	19,10	15,90	33,30	14,30	43,30	-	-	14,30	5,50	28,60	5,50	-	-	12,50
	in	1.06	0.81	0.68		0.49	0.10	0.75	0.62	1.31	0.56	1.70	-	-	0.56	0.22	1.12	0.22	-	-	0.49
10/3	mm	30	24,00	20,62	7/8 -14 UNF	16,00	2,80	23,10	17,50	39,60	15,90	47,60	-	-	18,30	6,50	34,00	6,50	-	-	14,00
	in	1.18	0.94	0.81		0.63	0.11	0.94	0.69	1.56	0.62	1.87	-	-	0.72	0.25	1.34	0.25	-	-	0.55
12/3	mm	38	29,23	24,73	1 1/16 -12 UNF	19,00	3,56	36,60	23,82	63,50	22,25	75,40	-	-	24,50	16,00	53,00	16,00	-	-	19,00
	in	1.50	1.15	0.97		0.75	0.14	1.44	0.94	2.5	0.88	2.97	-	-	0.96	0.63	2.09	0.63	-	-	0.75
16/3	mm	45	35,60	28,62	1 5/16 -12 UNF	22,00	3,50	36,50	28,62	64,30	27,02	75,30	-	-	24,50	16,00	53,00	16,00	-	-	19,00
	in	1.77	1.40	1.13		0.87	0.14	1.44	1.13	2.53	1.06	2.96	-	-	0.96	0.63	2.09	0.63	-	-	0.75
20/3	mm	58	43,60	36,55	1 5/8 -12 UNF	21,00	3,50	46,00	36,55	87,60	33,37	100	-	-	31	25,40	71,5	25,40	-	-	30,00
	in	2.28	1.71	1.44		0.83	0.14	1.81	1.04	3.45	1.31	3.93	-	-	1.22	1	2.81	1	-	-	1.18

Cavity plugs

Rougher tool

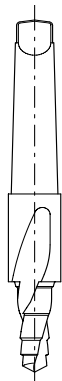

Cavity	Code number
08/3	3UT00052190
10/3	3UT00054170
12/3	3UT00054290
16/3	3UT00054470

Finisher tool



Cavity	Code number
08/3	3UT00052740
10/3	3UT00054180
12/3	3UT00054300
16/3	3UT00054480

Tap



Cavity	Code number
08/3	3UT03416UNF
10/3	3UT07814UNF
12/3	3UT0111612UN
16/3	3UT0151612UN

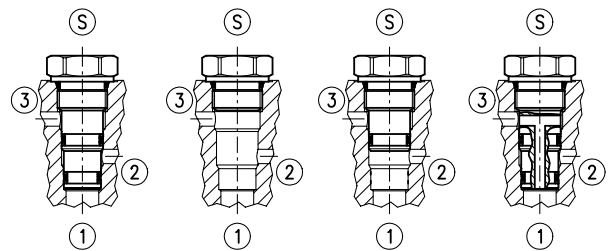

Cavity	Code number	①	②	③	S
08/3	3XTP3535100	X	X	X	X
	4TP5531500	0	0	0	X
	3XTP3534000	0	0	X	X
	3XTP3534800	0	X	0	X
10/3	3XTP3545700	X	X	X	X
	3XTP1542300	0	0	0	X
	3XTP3545701	0	X	0	X
12/3	3XTP3558200	X	X	X	X
	3XTP1552900	0	0	0	X
	3XTP35558201	0	X	0	X
16/3	3XTP3578400	X	X	X	X
	3XTP1572900	0	0	0	X

X=Closed 0=Open

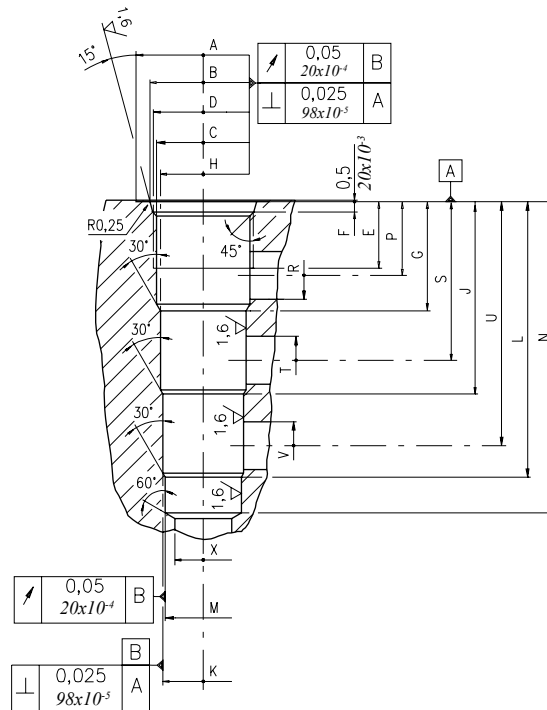

Cavity	A	B ±0,05	C ±0,05	D	E	F	G	H ±0,02	J	K ±0,02	L	M ±0,02	N	P	R φMAX	S φMAX	T φMAX	U	V φMAX	X φMAX	
08/4	mm	28,00	20,66	17,42	3/4-16 UNF	12,50	2,50	19,10	15,90	33,30	14,30	47,60	12,72	57,60	14,30	5,50	28,60	5,50	42,90	5,50	11,00
	in	1.10	0.81	0.68		0.49	0.10	0.75	0.62	1.31	0.56	1.87	0.50	2.27	0.56	0.22	1.12	0.22	1.69	0.22	0.43
10/4	mm	30	24,00	20,62	7/8-14 UNF	16,00	2,80	23,60	19,08	39,60	17,50	55,40	15,90	63,50	18,30	6,50	34,00	6,50	50,00	6,50	14,00
	in	1.18	0.94	0.81		0.63	0.11	0.93	0.75	1.56	0.69	2.18	0.62	2.50	0.72	0.26	1.34	0.25	1.97	0.25	0.55
12/4	mm	38	29,23	24,73	1 1/16-12 UNF	19,00	3,56	29,50	23,82	51,50	22,25	73,60	20,65	83,33	21,50	11,00	43,50	11,00	66,00	11,00	19,00
	in	1.50	1.15	0.97		0.75	0.14	1.16	0.94	2.03	0.87	2.90	0.81	3.28	0.85	0.43	1.71	0.43	2.60	0.43	0.75
16/4	mm	45	35,60	31,34	1 5/16-12 UNF	22,00	3,50	36,50	28,62	64,30	27,02	92,07	25,45	104,00	24,60	16,00	53,00	16,00	81,50	16,00	19,00
	in	1.77	1.40	1.23		0.87	0.14	1.44	1.13	2.53	1.06	3.62	1.00	4.09	0.97	0.63	2.09	0.63	3.21	0.63	0.75

Rougher tool

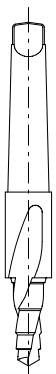

Finisher



Tap



Cavity plugs

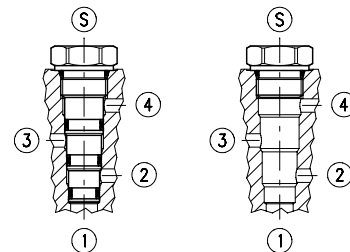

Cavity	Code number
08/4	3UT00052040
10/4	3UT00054250
12/4	3UT00054410
16/4	3UT00054820

Cavity	Code number
08/4	3UT00052020
10/4	3UT00054260
12/4	3UT00054420
16/4	3UT00054830

Cavity	Code number
08/4	3UT03416UNF
10/4	3UT07814UNF
12/4	3UT111612UN
16/4	3UT0151612UN

Cavity	Code number	①	②	③	④	⑤
08/4	3XTP3536500	X	X	X	X	X
	4TP5531500	0	0	0	0	X
10/4	3XTP3548301	X	X	X	X	X
	3XTP1542300	0	0	0	0	X
12/4	3XTP3559300	X	X	X	X	X
	3XTP1552900	0	0	0	0	X
16/4	3XTP357B300	X	X	X	X	X
	3XTP1572900	0	0	0	0	X

X=Closed 0=Open