



PK6222

PK-100-SFN14-HCPKG/US/ /W



Pressure sensors

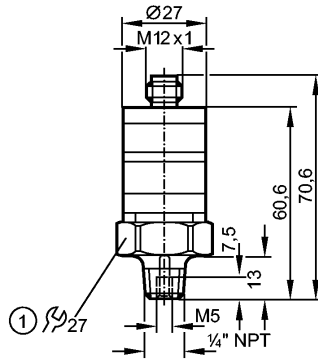

1: tightening torque 25 Nm



Product characteristics

Electronic pressure monitor

Quick disconnect

Process connection: 1/4" NPT A / M5 I

2 switching outputs
normally open / closed complementary

Measuring range: 0...100 bar / 0...1450 psi

Application

Application	Type of pressure: relative pressure Liquids and gases	
Pressure rating	200 bar	2900 psi
Bursting pressure min.	1000 bar	14500 psi
Medium temperature [°C]	-25...80	

Electrical data

Electrical design	DC PNP	
Operating voltage [V]	9.6...32 DC	
Current consumption [mA]	< 25	
Insulation resistance [MΩ]	> 100 (500 V DC)	
Protection class	III	
Reverse polarity protection	yes	

Outputs

Output	2 switching outputs normally open / closed complementary	
Output function	complementary	
Current rating [mA]	500	
Voltage drop [V]	< 2	
Short-circuit protection	yes (non-latching)	
Overload protection	yes	
Switching frequency [Hz]	100	

Measuring / setting range

Measuring range	0...100 bar	0...1450 psi
Setting range		
Set point, SP	5...100 bar	75...1450 psi
Reset point, rP	3...98 bar	50...1420 psi



PK6222

PK-100-SFN14-HCPKG/US/ /W



Pressure sensors

Accuracy / deviations

Deviations (% of value of measuring range)

Switch point accuracy	< ± 2.5 *
Characteristics deviation	< ± 1.5 (BFSL) / < ± 2.5 (LS) **)
Repeatability	< ± 0.5
Temperature drift (/ 10 K)	< ± 0.5
in the temperature range [°C]	0...80

Software / programming

Adjustment of the switch point	Setting rings
--------------------------------	---------------

Environment

Ambient temperature [°C]	-25...80
Storage temperature [°C]	-40...100
Protection	IP 67

Tests / approvals

EMC	EN 61000-4-2 ESD: 4 kV CD / 8 kV AD EN 61000-4-3 HF radiated: 10 V/m EN 61000-4-4 Burst: 2 kV EN 61000-4-5 Surge: 1 kV signal for DC units EN 61000-4-6 HF conducted: 10 V
Shock resistance	DIN IEC 68-2-27: 50 g (11 ms)
Vibration resistance	DIN IEC 68-2-6: 20 g (10...2000 Hz)
MTTF [Years]	540

Mechanical data

Process connection	¼" NPT A / M5 I
Materials (wetted parts)	stainless steel 316L / 1.4404
Housing materials	PBT (Pocan); PC (Makrolon); FPM (Viton); stainless steel 316L / 1.4404
Switching cycles min.	50 million
Weight [kg]	0.091

Displays / operating elements

Display	Power LED green Switching status LED yellow
---------	--

Electrical connection

Connection	M12 connector
------------	---------------

Wiring

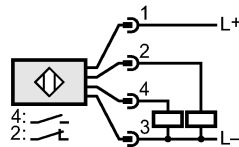

Remarks

Remarks	*) Setting accuracy **) BFSL = Best Fit Straight Line / LS = Limit Value Setting
---------	---

Pack quantity [piece]	1
-----------------------	---