



RPCER1

DIRECT OPERATED FLOW CONTROL VALVE WITH ELECTRIC PROPORTIONAL CONTROL AND POSITION FEEDBACK

SERIES 52

SUBPLATE MOUNTING
ISO 6263-03 (CETOP 03)

p max 250 bar

Q max (see performances table)

MOUNTING INTERFACE

ISO 6263-03-03-0-97
(CETOP 4.5.2-2-03-250)

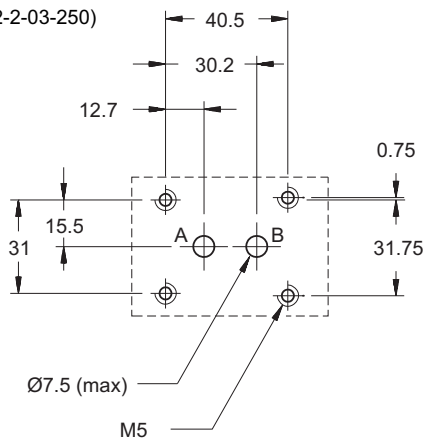

NOTE: The RPCER1 mounting interface, with holes according to ISO 6263-03 (CETOP 03), must not have P and T ports

PERFORMANCES (obtained with mineral oil with viscosity of 36 cSt at 50°C and UEIK-11RSQ/52-24 electronic card)

Maximum operating pressure	bar	250
Minimum Δp between A and B port		10
Maximum controlled flow	l/min	1,5 - 4 - 8 - 16 - 25
Min. controlled flow (for 1 and 4 l/min. reg.)		0,025
Maximum free-reverse flow		40
Step response	see paragraph 7	
Hysteresis	% of Q max	< 2,5%
Repeatability	% of Q max	< $\pm 1\%$
Electrical characteristic	see paragraph 6	
Ambient temperature range	°C	-10 / +50
Fluid temperature range	°C	-20 / +80
Fluid viscosity range	cSt	10 + 400
Fluid contamination degree	According to ISO 4406:1999 class 18/16/13 (class 17/15/12 for flows < 0,5 l/min)	
Recommended viscosity	cSt	25
Mass:	kg	2,2

OPERATING PRINCIPLE

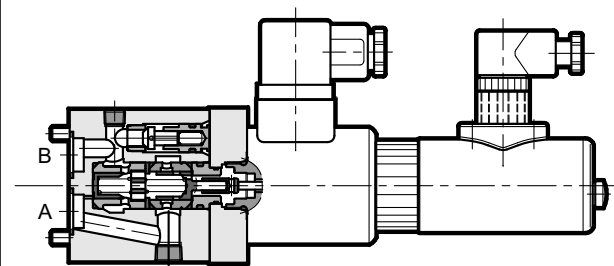

- RPCER1 is a pressure and temperature compensated two-way flow control valve, with electric proportional control and mounting interface in accordance with the ISO 6263 (CETOP RP121H) standards.
- The position feedback of the flow rate controlling throttle gives regulation conditions featuring highly reduced hysteresis and high repeatability.
- It is normally used to control the flow rate into an arm of the hydraulic circuit or the speed of the hydraulic actuators.
- The flow rate can be modulated continuously in proportion to the reference signal sent to the electronic control unit.
- It is available in five flow rate control ranges up to 25 l/min.

HYDRAULIC SYMBOLS

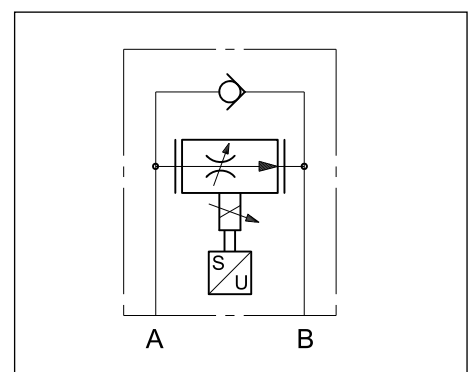

1 - IDENTIFICATION CODE

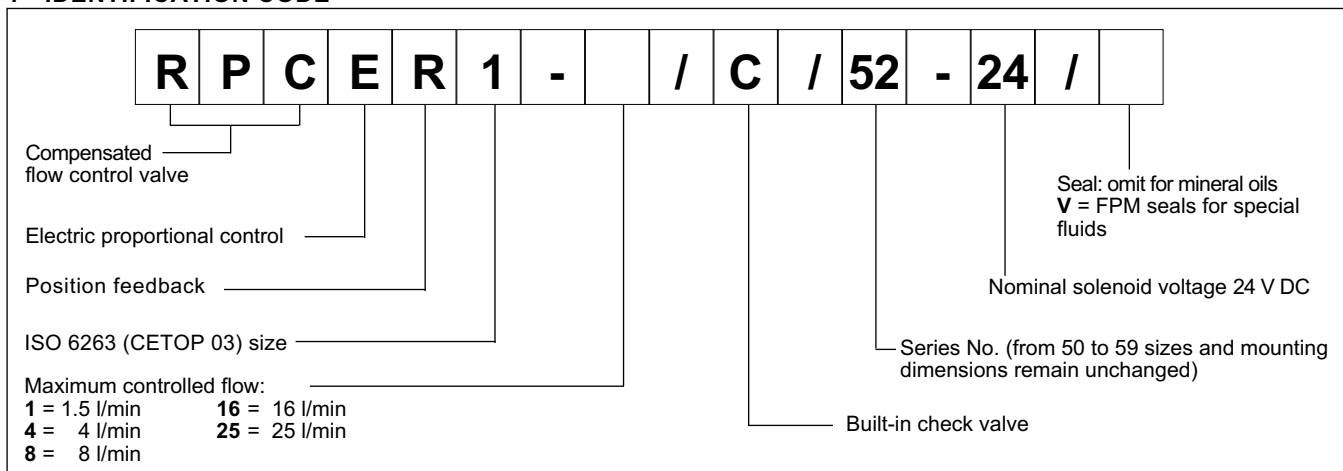

2 - CHARACTERISTIC CURVES (measured with viscosity of 36 cSt at 50°C and UEIK-11RSQ/52-24 card)

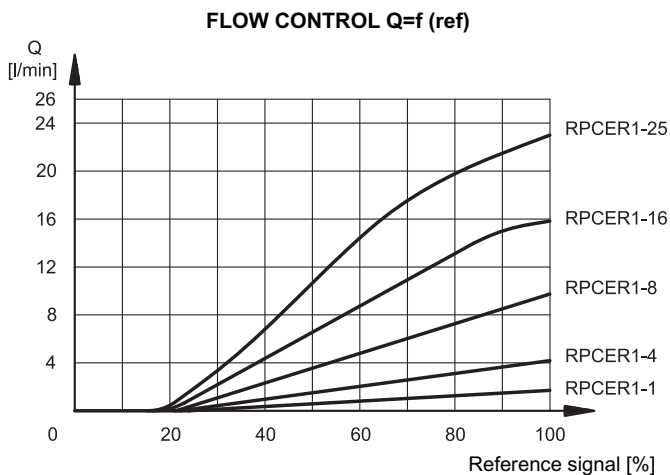

Typical curves for flow rate A → B according to the reference signal sent to the electronic control unit.

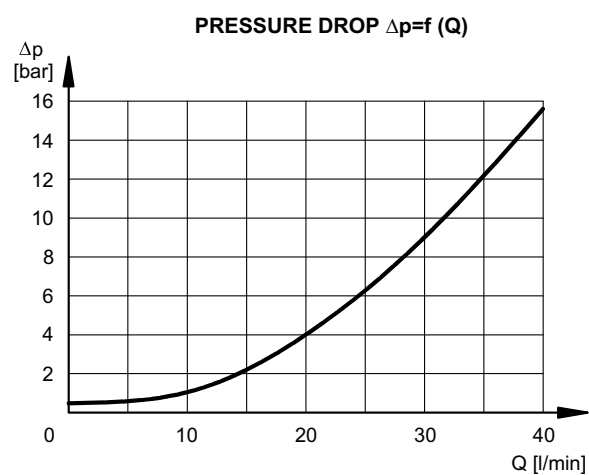

Pressure drop with free flow B → A through check valve.

3 - PRESSURE COMPENSATION

The valves are equipped with two restrictors in series. The first is an opening which can be adjusted by the proportional solenoid; the second, controlled by the pressure upstream and downstream of the first restrictor ensures constant pressure drop across the adjustable restrictor. In these conditions, the set flow rate value is maintained constant within a tolerance limit of $\pm 2\%$ of the full scale flow rate for maximum pressure variation between the valve inlet and outlet chambers.

4 - THERMAL COMPENSATION

Thermal compensation of the valve is obtained by adopting the principle of restricted fluid passage, so that the fluid is not influenced significantly by variations in oil viscosity.

For controlled flow rates of lower than 0.5 l/min and with a temperature change of 30°C, flow rate varies by approx. 13% of the set value.

For higher flow rates and with the same temperature change the flow rate variation is <4% of the set flow rate.

5 - HYDRAULIC FLUIDS

Use mineral oil-based hydraulic fluids HL or HM type, according to ISO 6743-4.

For these fluids, use NBR seals. For fluids HFDR type (phosphate esters) use FPM seals (code V). For the use of other kinds of fluid such as HFA, HFB, HFC, please consult our technical department.

Using fluids at temperatures higher than 80 °C causes a faster degradation of the fluid and of the seals characteristics. The fluid must be preserved in its physical and chemical characteristics.

6 - ELECTRICAL CHARACTERISTICS

6.1 - Proportional solenoid

The proportional solenoid comprises two parts: tube and coil.

The tube, screwed to the valve body, contains the armature which is designed to reduce friction to a minimum thereby reducing hysteresis.

The armature connected to the LVDT transducer core sends the position status to the electronic control unit.

6.2 - Positional transducer

The feedback control version RPCER1 uses an LVDT type positional transducer with amplified signal to enable precise control of the restrictor and the set flow rate, thus improving repeatability and hysteresis characteristics.

The transducer is fitted coaxially on the proportional solenoid and the connector features 360° positioning.

Technical specifications and connections are indicated here beside.

The transducer is protected against polarity inversion on the power line.

NOMINAL VOLTAGE	V DC	24
RESISTANCE (at 20°C)	Ω	17.6
MAXIMUM CURRENT	A	0.86
DUTY CYCLE	100%	
ELECTROMAGNETIC COMPATIBILITY (EMC)	According to 2004/108/CE	
CLASS OF PROTECTION: Atmospheric agents (CEI EN 60529)	IP 65	

Position transducer connection		Electronic card connections (see par. 10)
pin 1	supply 18 ÷ 36 V	pin 8c
pin 2	output 2 ÷ 10 V	pin 24a
pin 3	0 V	pin 22c
pin 4	NC	NC

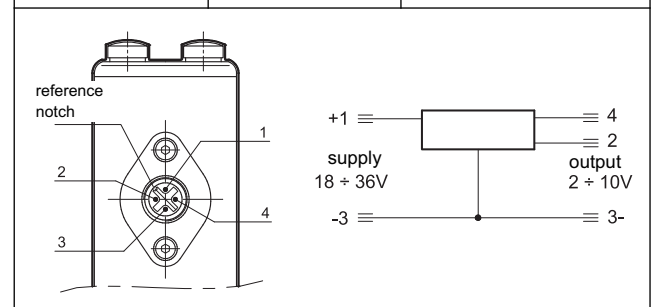

7 - STEP RESPONSE

(measured with mineral oil with viscosity of 36 cSt at 50°C with UEIK-11RSQ/52-24 electronic control unit)

Step response is the time taken for the valve to reach 90% of the set pressure value following a step change of reference signal.

The table illustrates typical response times with valve flow rate of 16 l/min and with input pressure of 100 bar.

REFERENCE SIGNAL STEP	0 → 100%	100 → 0%	25 → 100%	100 → 25%
Step response [ms]	180	150	150	120

8 - INSTALLATION

RPCER1 valves can be installed in any position without impairing correct operation.

Ensure that there is no air in the hydraulic circuit.

Valves are fixed by means of screws or tie rods on a flat surface with planarity and roughness equal to or better than those indicated in the relative symbols. If minimum values are not observed fluid can easily leak between the valve and mounting surface.

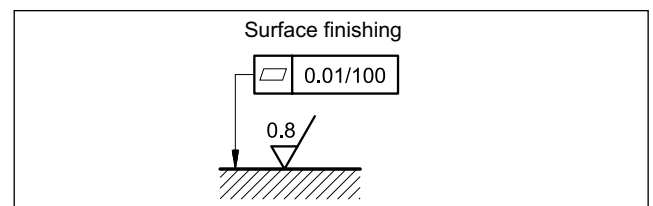

9 - OVERALL AND MOUNTING DIMENSIONS

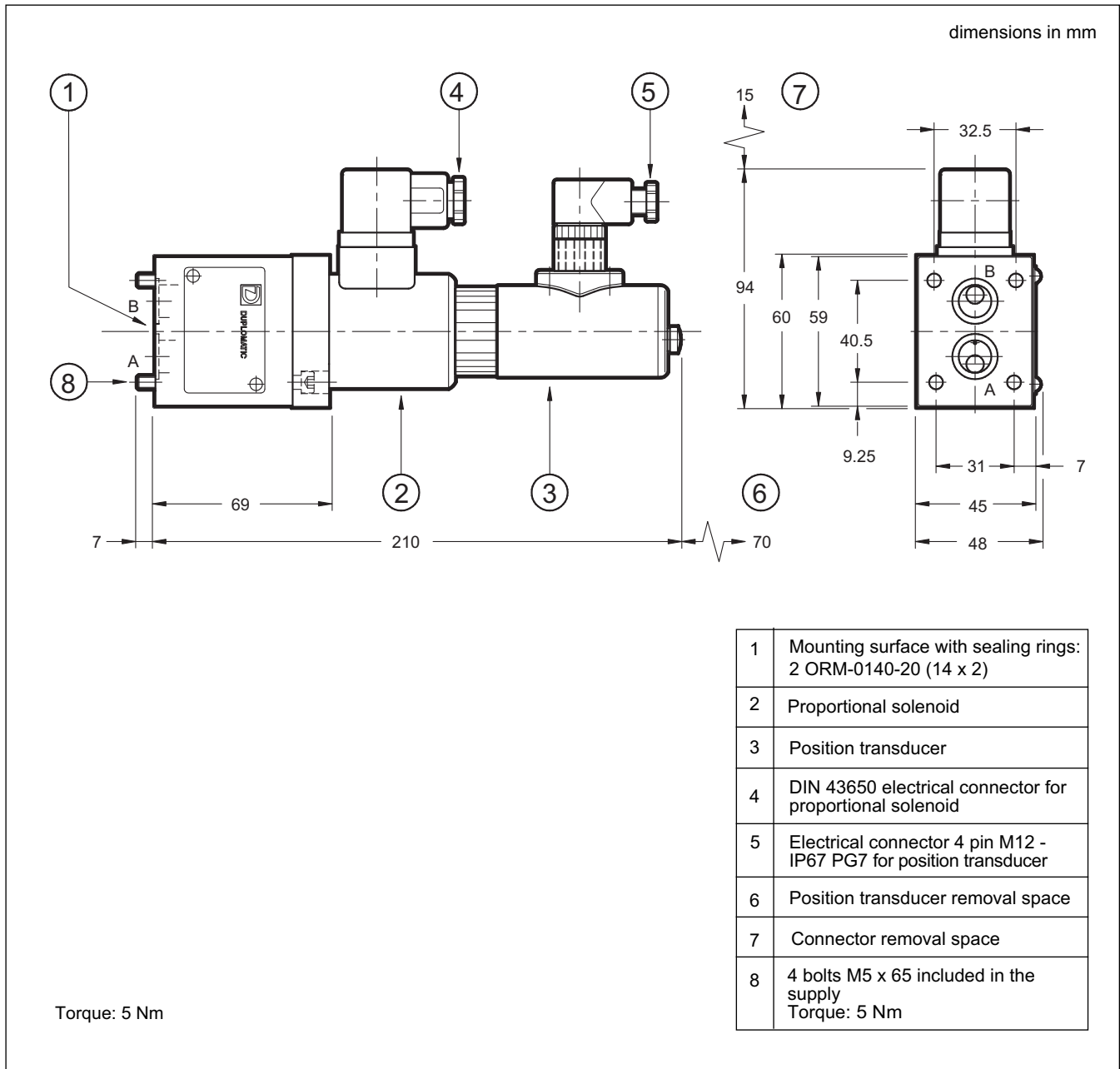

10 - ELECTRONIC CONTROL UNIT

UEIK-11RSQ/52-24	Eurocard format	see cat. 89 315
-------------------------	-----------------	-----------------

11 - SUBPLATES (see cat. 51 000)

Type	PMRPC1-AI3G rear ports PMRPC1-AL3G side ports
Port dimensions	3/8" BSP