

TA2814

TA-050FLEC01- - /US

Temperature sensors

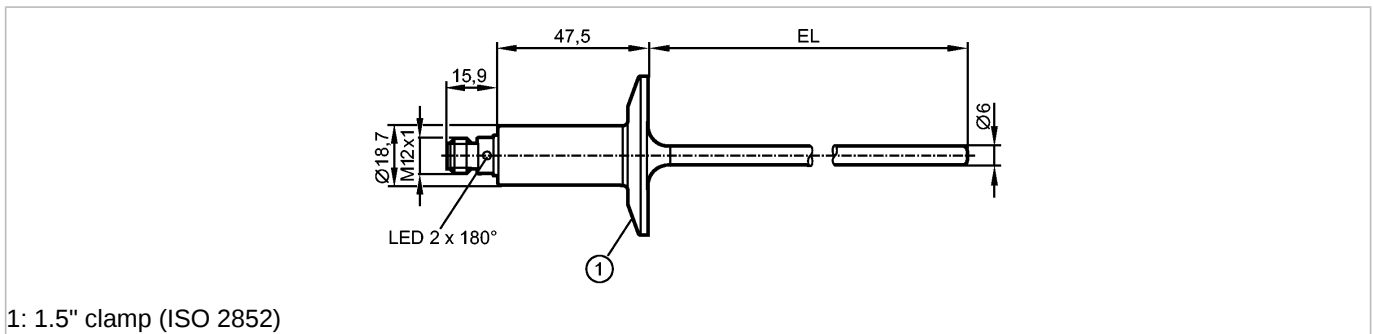

1: 1.5" clamp (ISO 2852)

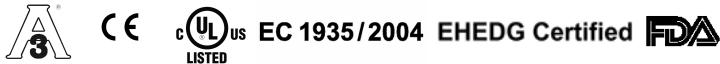

IO-Link

Product characteristics

Temperature transmitter
Process connection: 1.5" clamp (ISO 2852)
Installation length EL: 50 mm
Suitable for direct installation
Analog output
Measuring element: 1 x Pt 1000, to DIN EN 60751, class A
Factory setting: 0...350 °F

Application

Application	liquids and gases
Pressure rating [bar]	160
Vacuum resistance [mbar]	-1000

Electrical data

Electrical design	DC
Operating voltage [V]	18...32 DC; cULus - Class 2 source required
Current consumption [mA]	< 50
Protection class	III
Reverse polarity protection	yes

Outputs

Output	Analog output
Output function	4...20 mA analog
Short-circuit protection	yes
Overload protection	yes
Analog output	4...20 mA
Max. load [Ω]	250 (18...19 V); 300 (19...32 V)

Measuring / setting range

Factory setting	0...350 °F
Resolution	
Analog output [K]	≤ 0.04

Accuracy / deviations

Analog output [K]	± 0.3 + (± 0.1 % MS)
Temperature coefficients (in % of the span per 10 K)	0.1

Reaction times

TA2814

TA-050FLEC01- - /US

Temperature sensors

Power-on delay time	[s]	2
Dynamic response	T05 / T09 [s]	< 0.5 / < 2

Interfaces

IO-Link Device		
Transfer type		COM2 (38.4 kBaud)
IO-Link revision		1.1

Environment

Ambient temperature	[°C]	-25...80, at max. 160 °C medium temperature (-25...60 °C at max. 200 °C medium temperature)
Storage temperature	[°C]	-40...100
Protection		IP 67 / IP 68 / IP 69K

Tests / approvals

EMC		DIN EN 61000-6-2 DIN EN 61000-6-3
Shock resistance		DIN IEC 68-2-27: 50 g (11 ms)
Vibration resistance		DIN IEC 68-2-6: 10 g (10...2000 Hz)
MTTF	[Years]	232

Mechanical data

Process connection		1.5" clamp (ISO 2852)
Materials (wetted parts)		stainless steel 316L / 1.4404; surface characteristics Ra: < 0.6
Probe diameter	[mm]	6
Installation length EL	[mm]	50
Housing materials		stainless steel 316L / 1.4404; PEI; FKM
Weight	[kg]	0.221

Electrical connection

Connection		M12 connector
------------	--	---------------

Wiring

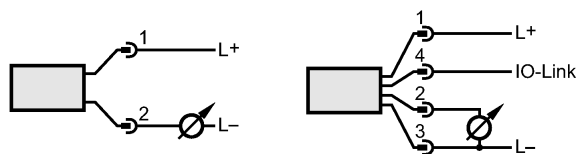

Remarks

Remarks		MS = set measuring span
Pack quantity	[piece]	1