

TD2291

TD-350CFED06-A-ZVG/US

Temperature sensors

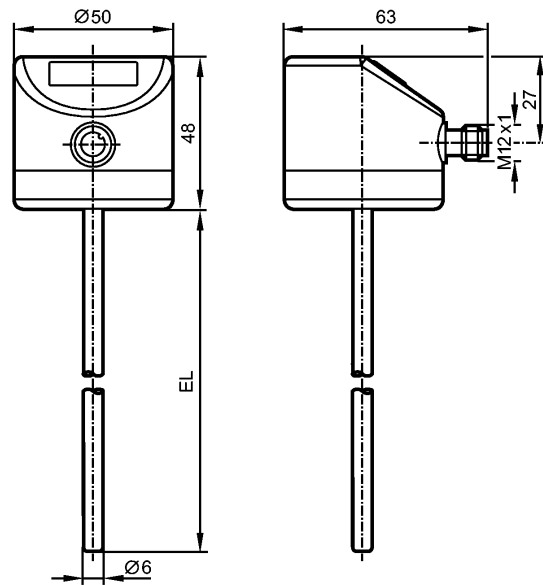

EL = Installation length



Product characteristics

Temperature Transmitter with Display
Process connection: Ø 6 mm
Installation length EL: 350 mm
Analog output
7-segment LED display (4 digits)
Measuring range: -50...150 °C / -58...302 °F
Measuring element: 1 x Pt 1000, to DIN EN 60751, class A
Factory setting: -10...150 °C

Application

Application	liquids and gases
Pressure rating [bar]	160
Vacuum resistance [mbar]	-1000

Electrical data

Electrical design	DC
Operating voltage [V]	18...32 DC; cULus - Class 2 source required
Current consumption [mA]	< 50
Protection class	III
Reverse polarity protection	yes

Outputs

Output	Analog output
Short-circuit protection	yes
Overload protection	yes
Analog output	4...20 mA
Max. load [Ω]	300

Measuring / setting range

Measuring range	-50...150 °C	-58...302 °F
Factory setting	-10...150 °C	

TD2291

TD-350CFED06-A-ZVG/US

Temperature sensors

Resolution

Analog output	[K]	≤ 0.04
Display	[K]	0.1

Accuracy / deviations

Analog output	[K]	± 0.3 + (± 0.1 % MS)
Temperature coefficients (in % of the span per 10 K)		0.1

Reaction times

Power-on delay time	[s]	2
Dynamic response	T05 / T09 [s]	1 / 3

Interfaces

IO-Link Device		
Transfer type		COM2 (38.4 kBaud)
IO-Link revision		1.1

Environment

Ambient temperature	[°C]	-25...80
Storage temperature	[°C]	-40...100
Protection		IP 67 / IP 68 / IP 69K

Tests / approvals

EMC		DIN EN 61000-6-2 DIN EN 61000-6-3
Shock resistance		DIN IEC 68-2-27: 50 g (11 ms)
Vibration resistance		DIN IEC 68-2-6: 10 g (10...2000 Hz)
MTTF	[Years]	407
UL approval number		K001

Mechanical data

Process connection		Ø 6 mm
Materials (wetted parts)		stainless steel 316L / 1.4404; surface characteristics Ra: < 0.6
Probe diameter	[mm]	6
Installation length EL	[mm]	350
Housing materials		housing: stainless steel 316L / 1.4404
Weight	[kg]	0.304

Displays / operating elements

Display		7-segment LED display (4 digits) Display unit / status °C / °F
---------	--	---

Electrical connection

Connection		M12 connector
------------	--	---------------

Wiring

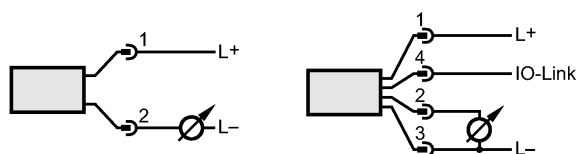

Remarks



TD2291

TD-350CFED06-A-ZVG/US

Temperature sensors

Remarks	MS = set measuring span
Pack quantity [piece]	1