

TD2547

TD-150CFER12-A-ZVG/US

Temperature sensors

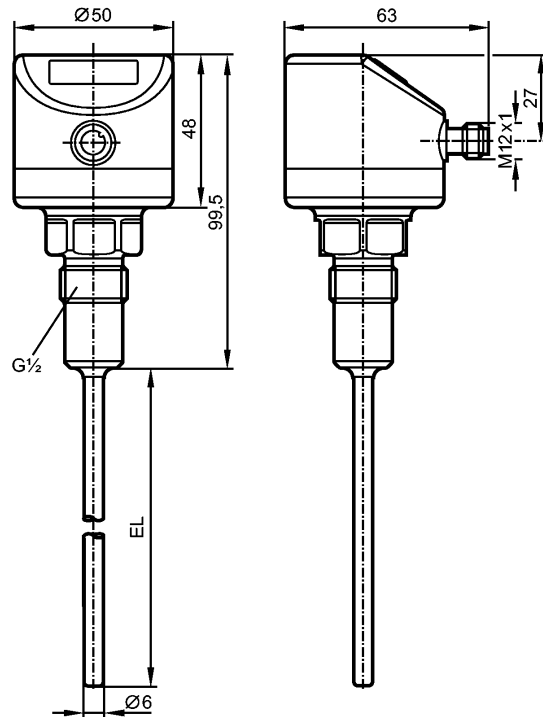

EL = Installation length

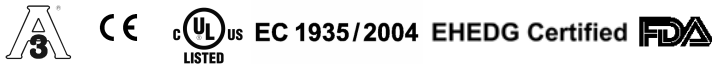

Product characteristics

Temperature Transmitter with Display	
Process connection: G½ with sealing cone	
Installation length EL: 150 mm	
Analog output	
7-segment LED display (4 digits)	
Measuring range: -50...150 °C / -58...302 °F	
Measuring element: 1 x Pt 1000, to DIN EN 60751, class A	
Factory setting: 0...100 °C	

Application

Application	liquids and gases
Pressure rating [bar]	160
Vacuum resistance [mbar]	-1000

Electrical data

Electrical design	DC
Operating voltage [V]	18...32 DC; cULus - Class 2 source required
Current consumption [mA]	< 50
Protection class	III
Reverse polarity protection	yes

Outputs

Output	Analog output
Short-circuit protection	yes
Overload protection	yes



TD2547

TD-150CFER12-A-ZVG/US

Temperature sensors

Analog output		4...20 mA
Max. load	[Ω]	300
Measuring / setting range		
Measuring range		-50...150 °C -58...302 °F
Factory setting		0...100 °C
Resolution		
Analog output	[K]	≤ 0.04
Display	[K]	0.1
Accuracy / deviations		
Analog output	[K]	± 0.3 + (± 0.1 % MS)
Temperature coefficients (in % of the span per 10 K)		0.1
Reaction times		
Power-on delay time	[s]	2
Dynamic response	T05 / T09 [s]	1 / 3
Interfaces		
IO-Link Device		
Transfer type		COM2 (38.4 kBaud)
IO-Link revision		1.1
Environment		
Ambient temperature	[°C]	-25...80
Storage temperature	[°C]	-40...100
Protection		IP 67 / IP 68 / IP 69K
Tests / approvals		
EMC		DIN EN 61000-6-2 DIN EN 61000-6-3
Shock resistance		DIN IEC 68-2-27: 50 g (11 ms)
Vibration resistance		DIN IEC 68-2-6: 10 g (10...2000 Hz)
MTTF	[Years]	405
UL approval number		K001
Mechanical data		
Process connection		G½ with sealing cone
Materials (wetted parts)		stainless steel 316L / 1.4404; surface characteristics Ra: < 0.6
Probe diameter	[mm]	6
Installation length EL	[mm]	150
Housing materials		housing: stainless steel 316L / 1.4404
Weight	[kg]	0.456
Displays / operating elements		
Display		7-segment LED display (4 digits) Display unit / status °C / °F
Electrical connection		
Connection		M12 connector
Wiring		

TD2547

TD-150CFER12-A-ZVG/US

Temperature sensors

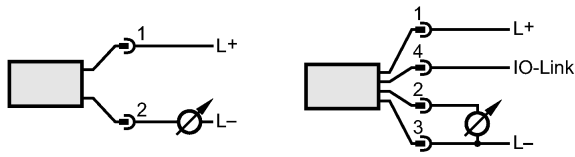

Remarks

Remarks	MS = set measuring span
Pack quantity [piece]	1