

**TD2817**

TD-050CFEC01-A-ZVG/US

Temperature sensors

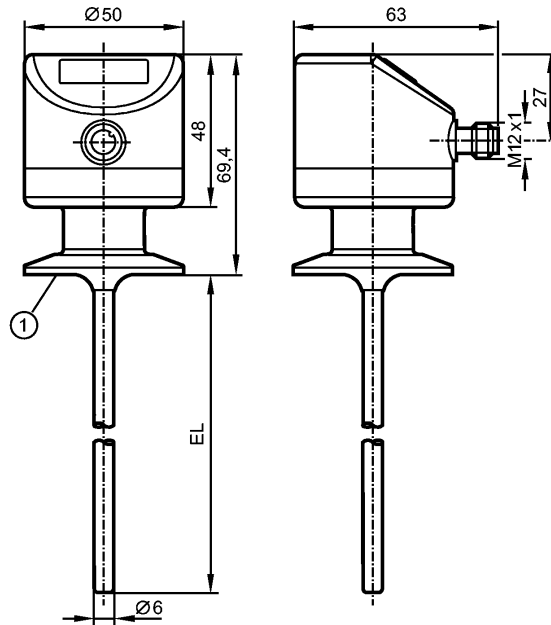

1: 1.5" clamp (ISO 2852)  
EL = Installation length

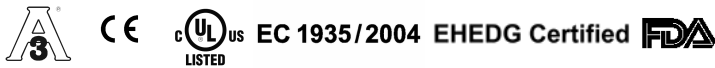

**IO-Link**

**Product characteristics**

Temperature Transmitter with Display
Process connection: 1.5" clamp (ISO 2852)
Installation length EL: 50 mm
Analog output
7-segment LED display (4 digits)
Measuring range: -50...150 °C / -58...302 °F
Measuring element: 1 x Pt 1000, to DIN EN 60751, class A
Factory setting: 0...100 °C

**Application**

Application	liquids and gases
Pressure rating [bar]	160
Vacuum resistance [mbar]	-1000

**Electrical data**

Electrical design	DC
Operating voltage [V]	18...32 DC; cULus - Class 2 source required
Current consumption [mA]	< 50
Protection class	III
Reverse polarity protection	yes

**Outputs**

Output	Analog output
Short-circuit protection	yes
Overload protection	yes
Analog output	4...20 mA

**TD2817**

TD-050CFEC01-A-ZVG/US

**Temperature sensors**

Max. load	[Ω]	300
<b>Measuring / setting range</b>		
Measuring range		-50...150 °C      -58...302 °F
Factory setting		0...100 °C
Resolution		
Analog output	[K]	≤ 0.04
Display	[K]	0.1
<b>Accuracy / deviations</b>		
Analog output	[K]	± 0.3 + (± 0.1 % MS)
Temperature coefficients (in % of the span per 10 K)		0.1
<b>Reaction times</b>		
Power-on delay time	[s]	2
Dynamic response	T05 / T09 [s]	1 / 3
<b>Interfaces</b>		
IO-Link Device		
Transfer type		COM2 (38.4 kBaud)
IO-Link revision		1.1
<b>Environment</b>		
Ambient temperature	[°C]	-25...80
Storage temperature	[°C]	-40...100
Protection		IP 67 / IP 68 / IP 69K
<b>Tests / approvals</b>		
EMC		DIN EN 61000-6-2 DIN EN 61000-6-3
Shock resistance		DIN IEC 68-2-27:      50 g (11 ms)
Vibration resistance		DIN IEC 68-2-6:      10 g (10...2000 Hz)
MTTF	[Years]	405
UL approval number		K001
<b>Mechanical data</b>		
Process connection		1.5" clamp (ISO 2852)
Materials (wetted parts)		stainless steel 316L / 1.4404; surface characteristics Ra: < 0.6
Probe diameter	[mm]	6
Installation length EL	[mm]	50
Housing materials		housing: stainless steel 316L / 1.4404
Weight	[kg]	0.271
<b>Displays / operating elements</b>		
Display		7-segment LED display (4 digits) Display unit / status      °C / °F
<b>Electrical connection</b>		
Connection		M12 connector
<b>Wiring</b>		

## TD2817

TD-050CFEC01-A-ZVG/US

Temperature sensors

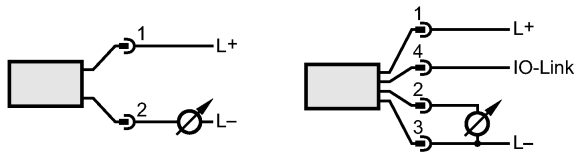

### Remarks

Remarks	MS = set measuring span
Pack quantity [piece]	1