

11.1.8 ACCESSORIES

Adapters

All adapters represented below serve to use the EPE pre-charge equipment on the accumulators of the main international manufacturers.

Type "A"

Adapter B2510

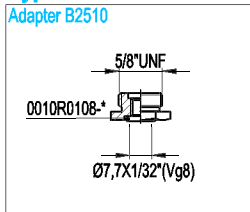

Type "B"

Adapter B2511

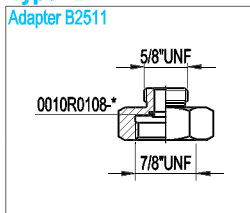

Type "C"

Adapter B2512

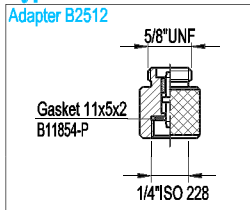

Type "D"

Adapter B2513

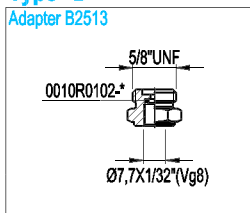

Type "E"

Adapter B2514

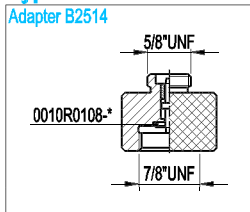

11.1e

Connection nipple for pressure reducer

The use of pre-charging equipment for the inflation of "low pressure" accumulators requires, for safety reasons, a pressure reducer (see Section 11.3) mounted on the nitrogen bottle, which is calibrated according to a pressure equal or lower than the maximum PS operating pressure, stamped on the accumulator shell.

The fitting nipple between the charging hose and the pressure reducer must be ordered separately with code 11447.

Nipple No. B2515

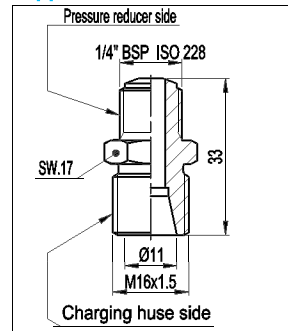

for pressure reducer see chapter 11.3

11.1f

Adapter. 2431

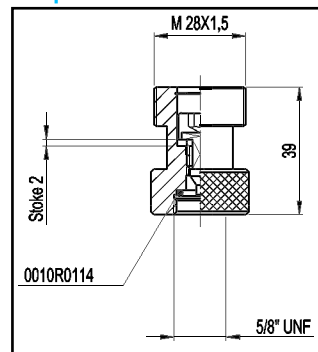

11.2c