

Pressure-Relief Cartridge Valve, Size 10

$Q_{\max} = 140 \text{ l/min}$, $p_{\max} = 450 \text{ bar}$
for cross-line relief function, direct acting, seat valve design
Series DDPDB-3D ...

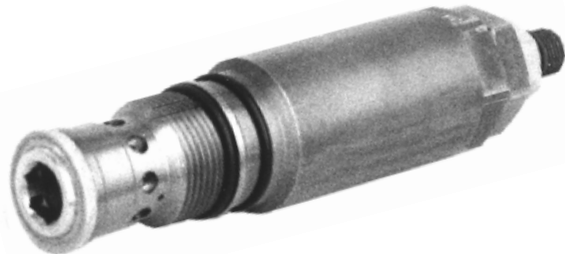

- Seat valve design gives virtually zero-leakage closure from port A to B and B to A
- Pressures to 450 bar on all ports (see model code key)
- Ideal for service line relief, sequence or pre-load functions (fast and stable response)
- Available in line mounting body DD-12 (G 1/2")
- Also available in ISO / CETOP 05 stack mounting body

1. Description

Series DDPDB-3D-10 ... cartridges are direct acting pressure relief valves for combined cross-line relief duties i.e. pressure is relieved either from A-to-B or from B-to-A as necessary (see symbol). These dual function cartridges can replace 2 conventional cartridge valves, with corresponding savings in space and cost. Their seat valve design ensures virtually zero leakage and they are designed to fit BUCHER cavity type DD. The spring chamber is exter-

nally drained via port Y which must be run directly to tank without any significant back pressure. The cartridge is designed to be fitted with a normal 27 A/F OE spanner (use the correct tightening torque). For customers who manufacture their own manifold blocks, we offer form tool sets for sale or hire. The line- and manifold mounting body DD-12 is available for line mounting applications.

2. Symbols

DDPDB-3D-10...

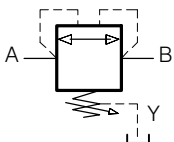

3. Characteristics

Type		pressure relief cartridge valve for cross-line relief duty (A \Rightarrow B and B \Rightarrow A)
Design		direct acting seat valve, i.e. poppet type
Mounting method		screw-in cartridge
Size		10 mm nominal size, BUCHER cavity type DD
Mass	kg	0,35
Mounting attitude		unrestricted
Flow direction		A \Rightarrow B and B \Rightarrow A, see symbol
Operating pressure p_{\max}	bar	... 450 in A, B and Y, for proper functioning, Y must be run directly to tank
Adjustment ranges, see performance curves	bar	pressure range P = 350 ... 450 pressure range O = 300 ... 400 pressure range N = 180 ... 350 pressure range M = 80 ... 240 pressure range L = 10 ... 100
Flow rate Q_{\max}	l/min	140, see performance curves

Fluids		Hydraulic oils HL and HLP to DIN 51 524 other fluids - contact BUCHER
Fluid temperature range	°C	-25 ... +80
Viscosity range	cSt	10 ... 650 mm ² /s, recommended 15 ... 250 mm ² /s
Minimum fluid cleanliness		20/18/15 to ISO 4406 : 1999

4. Application example

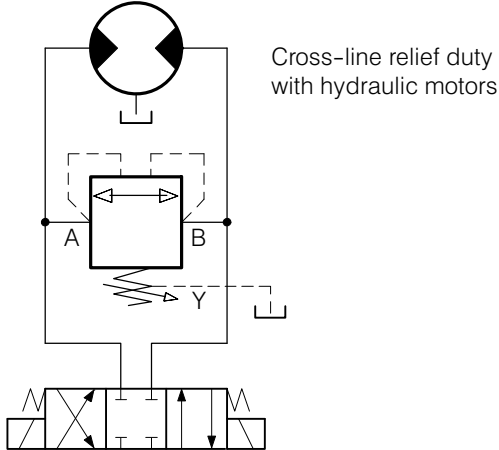

5. Performance characteristics

Oil viscosity 33 cSt

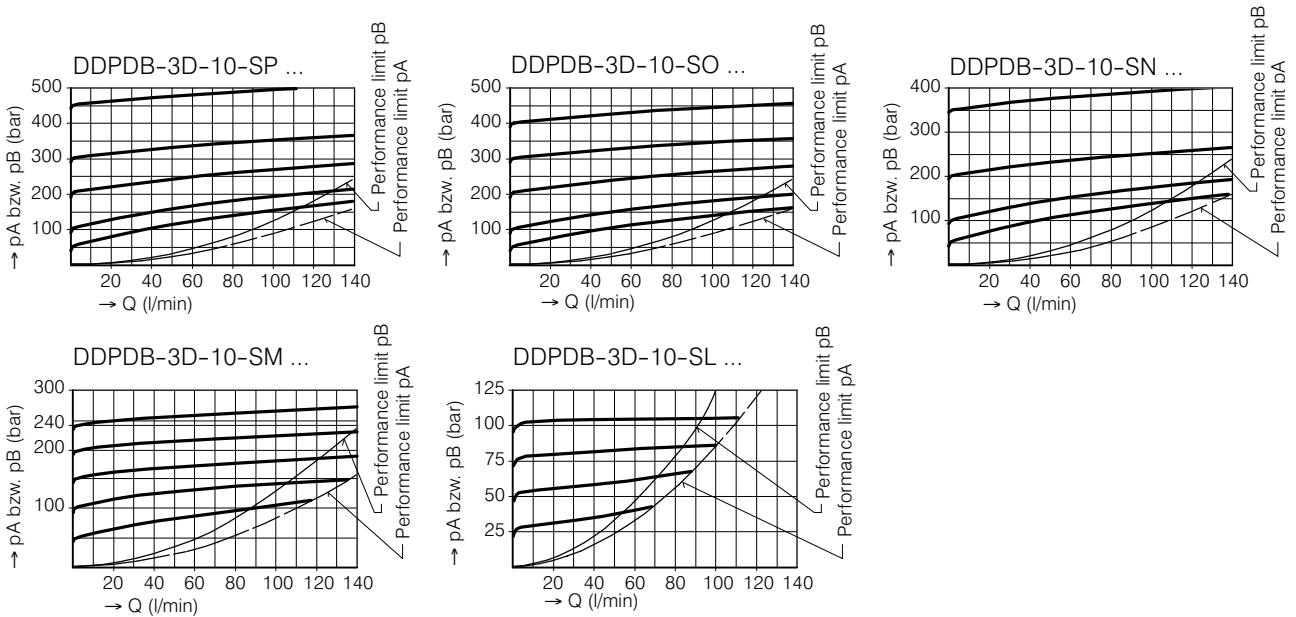

6. Dimensions

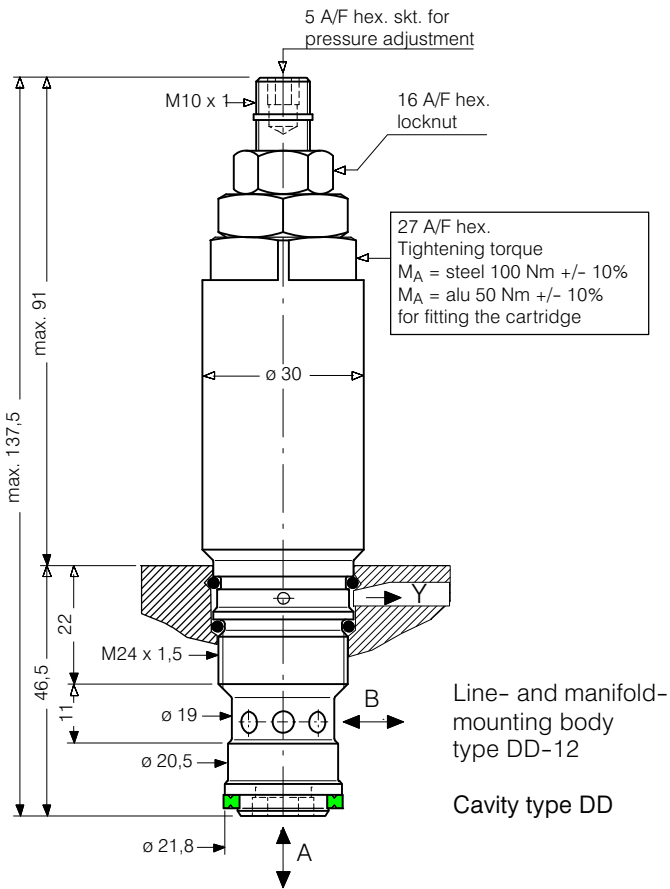

7. Schematic section

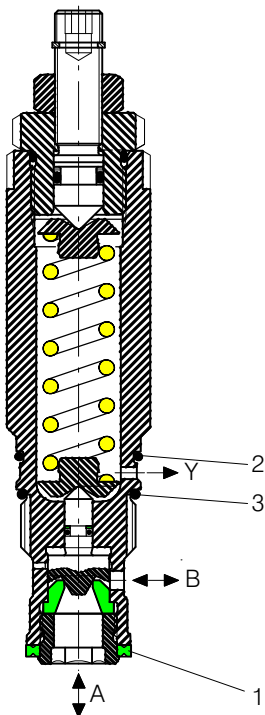

Seal kit no. DS-255, comprising:

Itm.	Qty.	Description	Dimension
1	1	Sealing ring	$\phi 22,1 / 16,1 \times 2,5$
2	1	O-ring no. 020	$\phi 21,95 \times 1,78 \text{ N90}$
3	1	O-ring	$\phi 21,00 \times 2,00 \text{ N75}$

8. Installation and servicing

All installation and servicing must be carried out with care, and by qualified personnel only. When changing seals, the

new seals must be thoroughly oiled or greased before they are fitted. Use the correct tightening torques at all times.

9. Model code key

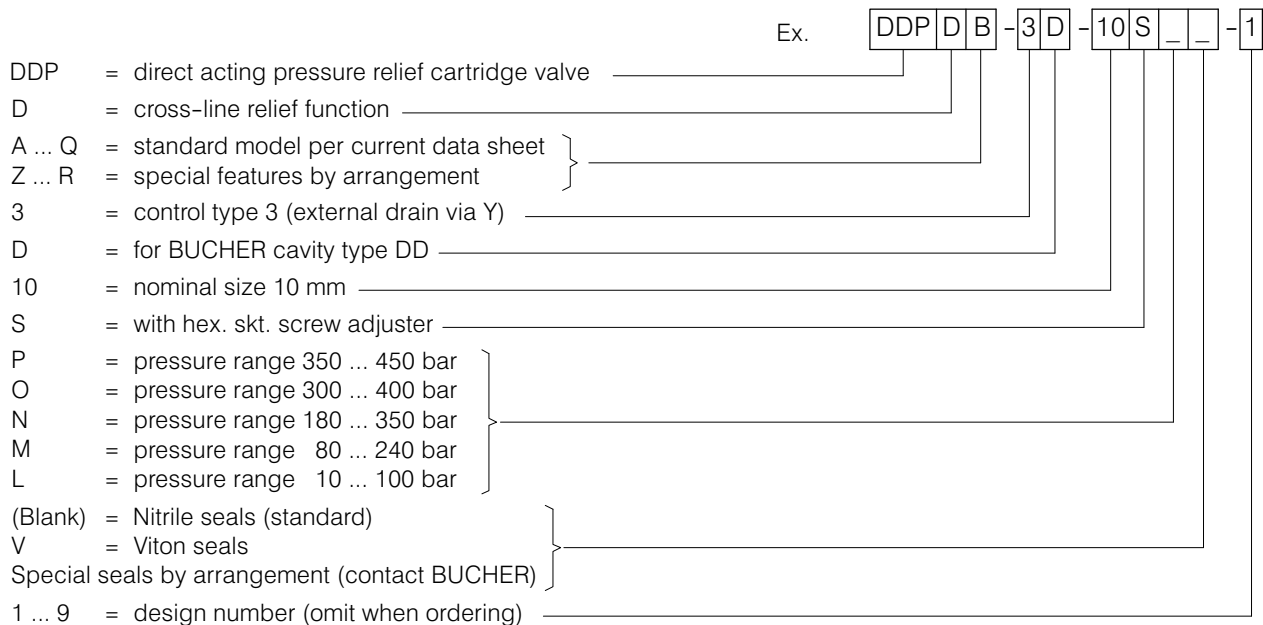

10. Related data sheets

Old no.	New no.	
i-32.00	400-P-040011-EN	The Form Tool hire programme
i-45.20	400-P-060121-EN	BUCHER cavity type DD
G-24.21	400-P-740111-EN	Line- and manifold mounting body type DD-12 (G 1/2")

info.ch@bucherhydraulics.com

www.bucherhydraulics.com

© 2016 by Bucher Hydraulics AG Frutigen, CH-3714 Frutigen

All rights reserved.

Data is provided for the purpose of product description only, and must not be construed as warranted characteristics in the legal sense. The information does not relieve users from the duty of conducting their own evaluations and tests. Because the products are subject to continual improvement, we reserve the right to amend the product specifications contained in this catalogue.

Classification: 450310.305.320.355