

# Proportional 3-Way Pressure-Reducing Cart., Size 4

$Q_{\max} = 20 \text{ l/min}$ ,  $p_{\max} = 210 \text{ bar}$   
 Direct acting, electrically operated  
 Series DRRY-7020... to 7100...

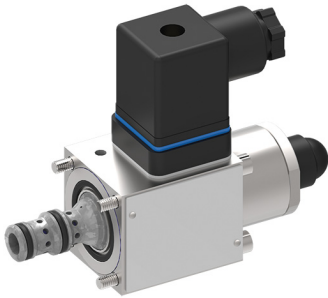

- Compact push-in cartridge construction for cavity type AG
- Operated by a proportional solenoid
- 4 pressure ranges available
- Excellent stability over the whole pressure and flow range
- All exposed parts with zinc-nickel plating
- High pressure wet-armature solenoids
- Various plug-connector systems and voltages are available
- Can be fitted in a line-mounting body

## 1 Description

Series DRRY-70... proportional 3-way pressure-reducing cartridges are direct acting, spool-type, push-in cartridges and are available in size 4. They reduce the outlet pressure in A as a function of the control current signal and independently of the inlet pressure in P. In the initial position (solenoid de-energised) the inlet of the 3-way pressure-reducing cartridge is shut off and the outlet is connected to tank (port A → T). In control mode, the connection P → A opens until the pressure in port A reaches the preset level. If the pressure rises above the preset level, the control spool opens the A → T connection until balance is attained. Four pressure ranges are available, with maximum operating pres-

sure (inlet pressure)  $p_{\max} 210 \text{ bar}$ . These 3-way pressure-reducing cartridges are predominantly used for reducing a system pressure in mobile and industrial applications. They are suitable for controlling larger directional valves, where they can be incorporated in the valve body or directly in the end covers, for example, and for controlling pumps and motors. All external parts of the cartridge are zinc-nickel plated to DIN 50 979 and are thus suitable for use in the harshest operating environments. If you intend to manufacture your own cavities or are designing a line-mounting installation, please refer to the section "Related data sheets".

## 2 Symbol

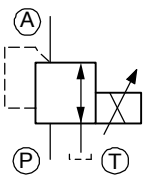

## 3 Technical data

General characteristics	Description, value, unit
Designation	proportional 3-way pressure-reducing cartridge
Design	direct acting, electrically operated
Mounting method	push-in cartridge, 4 mounting bolts M4x50
Tightening torque	2.6 Nm ± 10 %
Size	nominal size 4, cavity type AG
Weight	0.55 kg
Mounting attitude	unrestricted (preferably vertical, coil down)
Ambient temperature range	-25 °C ... +50 °C

Hydraulic characteristics	Description, value, unit
Maximum operating pressure $p_{max}$ (inlet pressure)	210 bar, all pressure ranges
Flow range	...20 l/min
Nominal pressure ranges $p_N$ <ul style="list-style-type: none"> <li>- model "100"</li> <li>- model "050"</li> <li>- model "030"</li> <li>- model "020"</li> </ul>	...100 bar ...50 bar ...30 bar ...20 bar
Back pressure in T <ul style="list-style-type: none"> <li>- static, not controlling</li> <li>- while controlling</li> </ul>	$p_{max}$ 50 bar $< 2 \% p_N$
Flow direction	see symbols
Hydraulic fluid	HL and HLP mineral oil to DIN 51 524; for other fluids, please contact BUCHER
Hydraulic fluid temperature range	-25 °C ... +70 °C
Viscosity range	15...380 mm <sup>2</sup> /s (cSt), recommended 20...130 mm <sup>2</sup> /s (cSt)
Minimum fluid cleanliness Cleanliness class to ISO 4406 : 1999	class 18/16/13

Electrical characteristics	Description, value, unit
Supply voltage	12 V DC, 24 V DC
Control current	12 V = 0...1400 mA, 24 V = 0...800 mA
Coil resistance R <ul style="list-style-type: none"> <li>- cold value at 20 °C</li> <li>- cold value at -25 °C</li> <li>- max. warm value</li> </ul>	12 V = 6.4 $\Omega$ / 24 V = 17.2 $\Omega$ 12 V = 5.2 $\Omega$ / 24 V = 14.1 $\Omega$ 12 V = 10.0 $\Omega$ / 24 V = 27.0 $\Omega$
Inductance Measured non-operated, at 0.1 mA (rms) / 1 kHz	12 V = 13 mH    24 V = 38 mH
Recommended PWM frequency (dither)	200 Hz
Hysteresis with PWM	2...4 % $I_N$
Reversal error with PWM	2...4 % $I_N$
Sensitivity with PWM	$< 1 \% I_N$
Reproducibility with PWM	$< 2 \% p_N$
Relative duty cycle	100 %
Nominal power consumption	max. 19 W
Insulation class to VDE 0580	H (180 °C)
Protection class to ISO 20 653 / EN 60 529	IP 65 / IP 67, see "Ordering code" (with appropriate mating connector and proper fitting and sealing)
Electrical connection	3-pin square plug to ISO 4400 / DIN 43 650 (standard) for other connectors, see "Ordering code"

## 4 Performance graphs measured with oil viscosity 33 mm<sup>2</sup>/s (cSt)

$p = f(I)$  Pressure adjustment characteristic

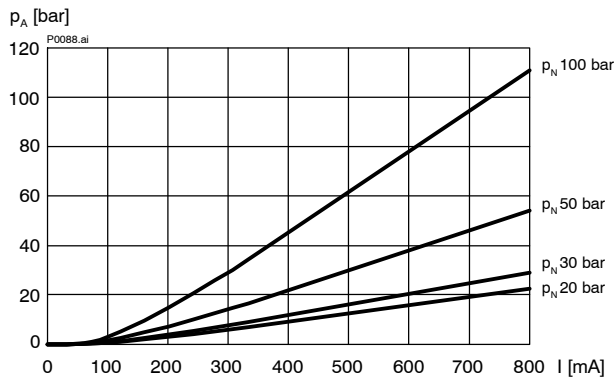

$p = f(I)$  Pressure adjustment characteristic

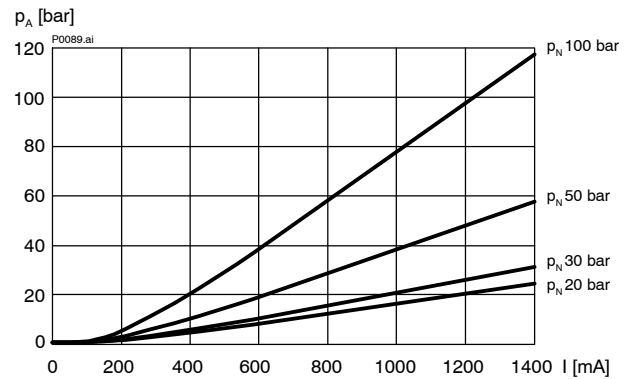

$p = f(Q)$  Pressure - Flow rate characteristic [DDRRY-7100...]

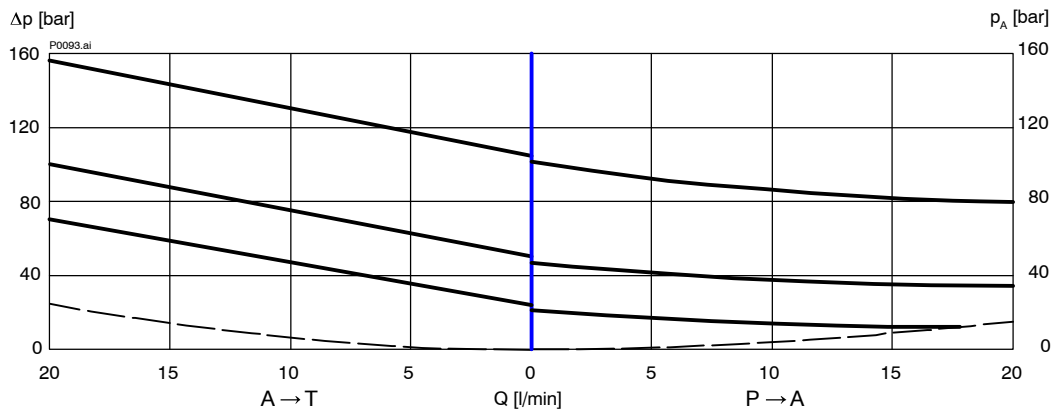

$p = f(Q)$  Pressure - Flow rate characteristic [DDRRY-7050...]

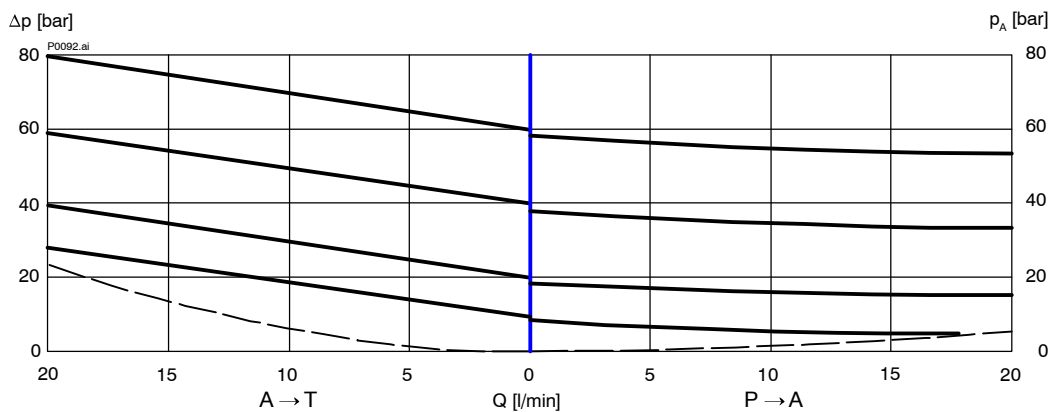

$p = f(Q)$  Pressure - Flow rate characteristic [DDRRY-7030...]

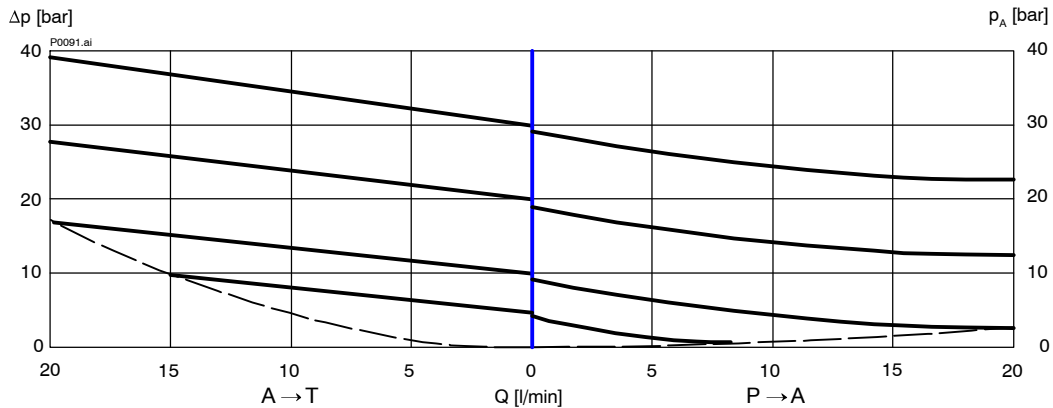

$p = f(Q)$  Pressure - Flow rate characteristic [DDRRY-7020...]

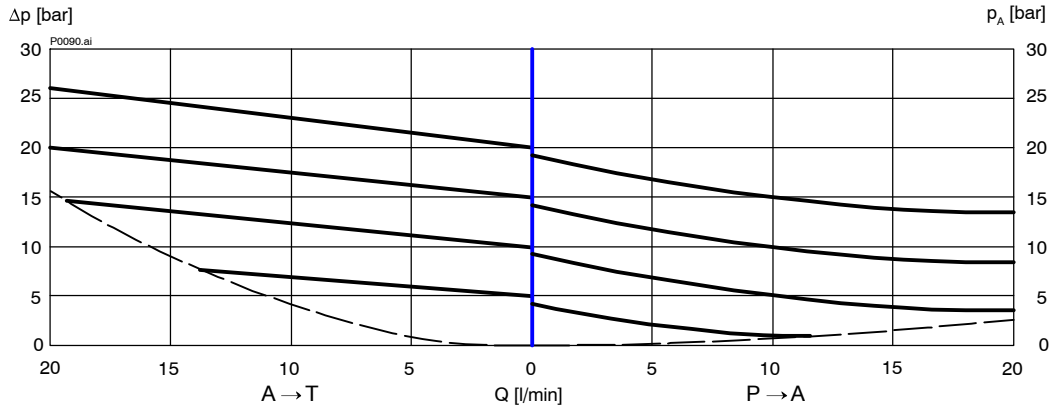

## 5 Dimensions & sectional view

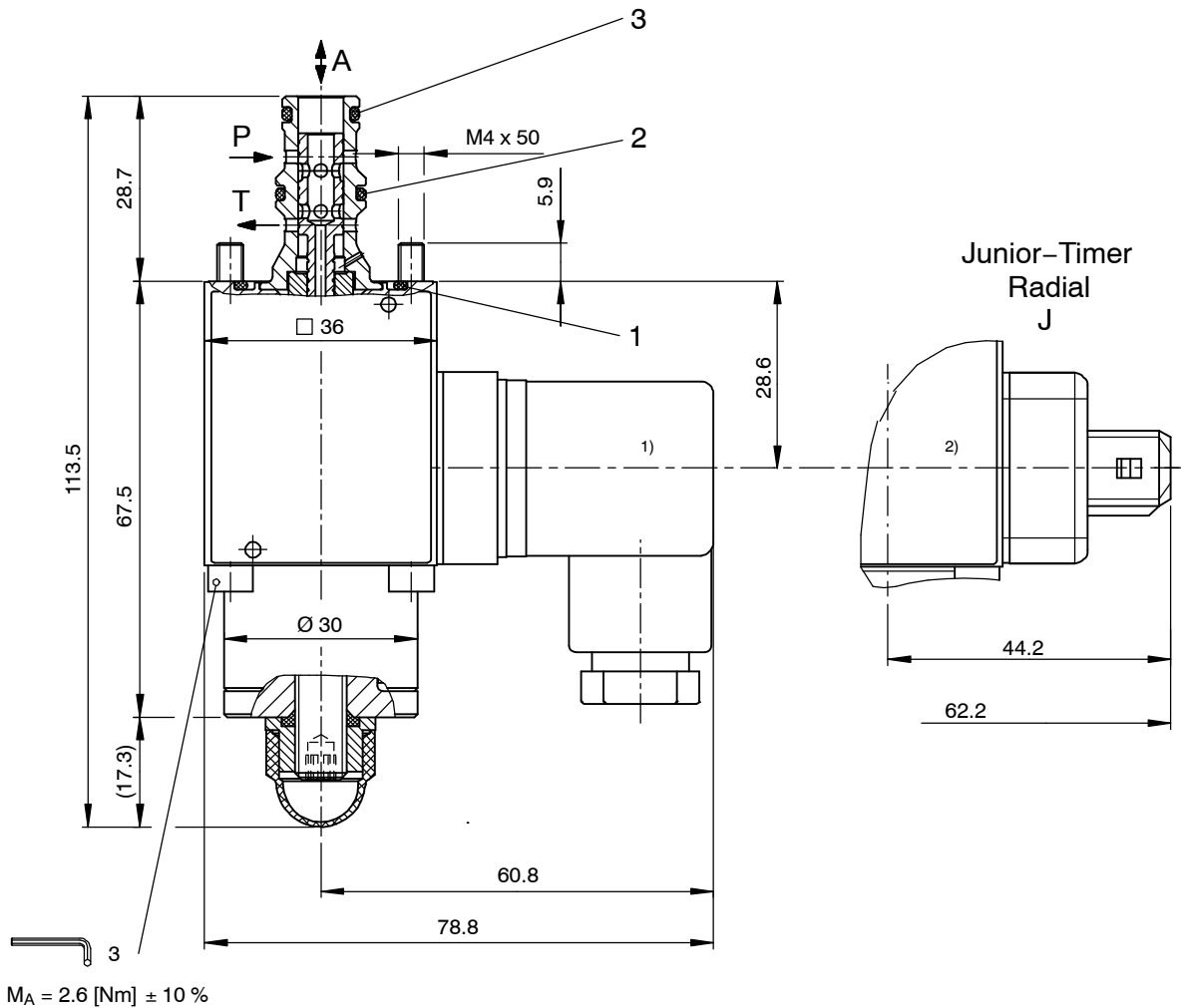

- 1) ISO 4400 / DIN 43 650 mating plug connection
- 2) Junior Timer Radial plug connection

## 6 Installation information



### IMPORTANT!

When fitting the cartridges, note the mounting attitude (preferably vertical, with coil down → automatic air bleed) and use the specified tightening torque. No adjustments are necessary, since the cartridges are set in the factory.



### ATTENTION!

Only qualified personnel with mechanical skills may carry out any maintenance work. Generally, the only work that should ever be undertaken is to check, and possibly replace, the seals. When changing seals, oil or grease the new seals thoroughly before fitting them.

### Seal kit NBR no. DS-154-N <sup>3)</sup>

Item	Qty.	Description
1	1	O-ring no. 021 Ø 23,52 x 1,78 V70
2	1	O-ring no. 013 Ø 10,82 x 1,78 N70
3	1	O-ring no. 012 Ø 9,25 x 1,78 N70



### IMPORTANT!

<sup>3)</sup> Seal kit with FKM (Viton) seals, no. DS-154-V

## 7 Ordering code

Ex. **DDRRY** - **7** **100** - **4** - **\_** - **2** **24** **D** **\_**

DDRRY = proportional pressure-reducing cartridge, direct acting

7 = pressure function, 3 way design

100 = pressure range ...100 bar

050 = pressure range ...50 bar

030 = pressure range ...30 bar

020 = pressure range ...20 bar

4 = nominal size 4

(blank) = NBR (Nitrile) seals (standard)

V = FKM (Viton) seals  
(special seals - please contact BUCHER)

1 ... 9 = design stage (omit when ordering new units)

... = voltage e.g. 24 (24 V)

D = current DC

(blank) = ISO 4400 / DIN 43 650 mating plug (standard, IP 65)

M100 = without mating DIN plug

J = Junior Timer radial plug connection without mating plug (protection class IP 65)

D = Deutsch plug connection DT04-2P without mating plug (protection class IP 67) on request

## 8 Related data sheets

Reference	(Old no.)	Description
400-P-040011	(i-32)	The form-tool hire programme
400-P-040141	(i-33.5)	Cavity type AG
400-P-510101		Amplifier unit for proportional valves (1-channel) PBS - 3A
400-P-511101	(P-3)	Amplifier card, 1-channel for valves with one solenoid, type SAN-535...
400-P-712101	(G-2.50)	Line-mounting body, type GAAA (G 1/4")

info.ch@bucherhydraulics.com

www.bucherhydraulics.com

© 2015 by Bucher Hydraulics AG Frutigen, CH-3714 Frutigen

All rights reserved.

Data is provided for the purpose of product description only, and must not be construed as warranted characteristics in the legal sense. The information does not relieve users from the duty of conducting their own evaluations and tests. Because the products are subject to continual improvement, we reserve the right to amend the product specifications contained in this catalogue.

Classification: 430.305.305.305.310