

Pressure-Reducing Cartridge Valve, Size 10

$Q_{max} = 120 \text{ l/min}$, $p_{max} = 350 \text{ bar}$
poppet pilot stage, spool-type main stage
Series DRPA-5 ...



- Pilot oil drained externally to port Z
- Interchangeable with DRP-5-10 ...
- Very stable in operation
- Improved pressure-setting resolution
- Very tolerant of over-tightening in cavity
- BUCHER cavity type DD
- Available in ISO / CETOP 3 and 5 stack mounting body

1. Description

Series DRPA-5-10... cartridges are 2-stage pressure reducing valves with a positive seat pilot stage and spool-type main stage. When the pilot stage is active (main stage reducing), pilot oil is externally drained to port Z. In this condition the secondary pressure in A will be maintained at the set level, as long as the primary pressure in B does not fall below that value. Thoroughly oil or grease external

seals before inserting the cartridge in a DD cavity. The cartridge can be tightened with a 27 A/F OE spanner (note the recommended tightening torque). Form tools are available for sale or hire, should customers wish to machine cavities in their own control blocks. The BUCHER line- and manifold-mounting body type DD-12 can be used where the application requires a line mounting valve.

2. Symbols

DRPA-5-10 ...

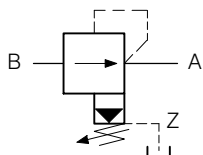

3. Characteristics

Type		pressure reducing cartridge valve
Design		poppet pilot stage, spool main stage with external pilot drain to port Z
Mounting method		screw-in cartridge (M24 x 1,5)
Size		10 mm nominal size, BUCHER cavity type DD
Mass	kg	0,23
Mounting attitude		unrestricted
Flow direction		$B \Rightarrow A$, see symbol
Operating pressure p_{max}	bar	... 350 in A, B and Z
Adjustment ranges, see performance curves	bar	pressure range N = 10 ... 350 pressure range M = 10 ... 210 pressure range L = 10 ... 65
Flow rate Q_{max}	l/min	1 ... 120 see performance characteristics
Fluids		Hydraulic oils HL and HLP to DIN 51 524 other fluids - contact BUCHER
Fluid temperature range	°C	-25 ... +80
Viscosity range	cSt	10 ... 650 mm ² /s, recommended 15 ... 250 mm ² /s
Minimum fluid cleanliness		20/18/15 to ISO 4406 : 1999

Reference: 400-P-280201-EN-01

4. Performance characteristics

Oil viscosity 33 cSt

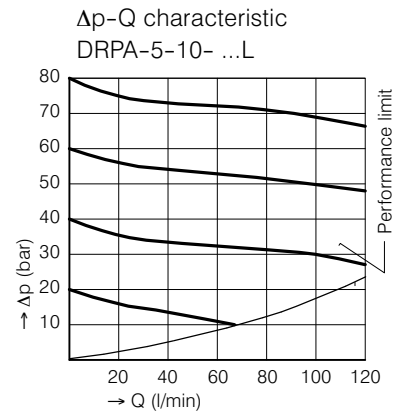
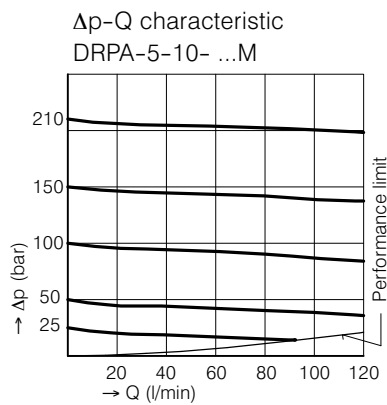
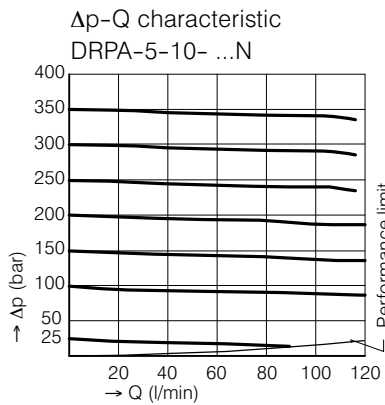

Rate of pressure change when turning the adjusting screw

DRPA-5-10-...N: 1 turn \cong	approx. 65 bar
DRPA-5-10-...M: 1 turn \cong	approx. 38 bar
DRPA-5-10-...L: 1 turn \cong	approx. 13 bar

Pilot flow A \Rightarrow Z:
approx. 300 cm³ / min

5. Dimensions

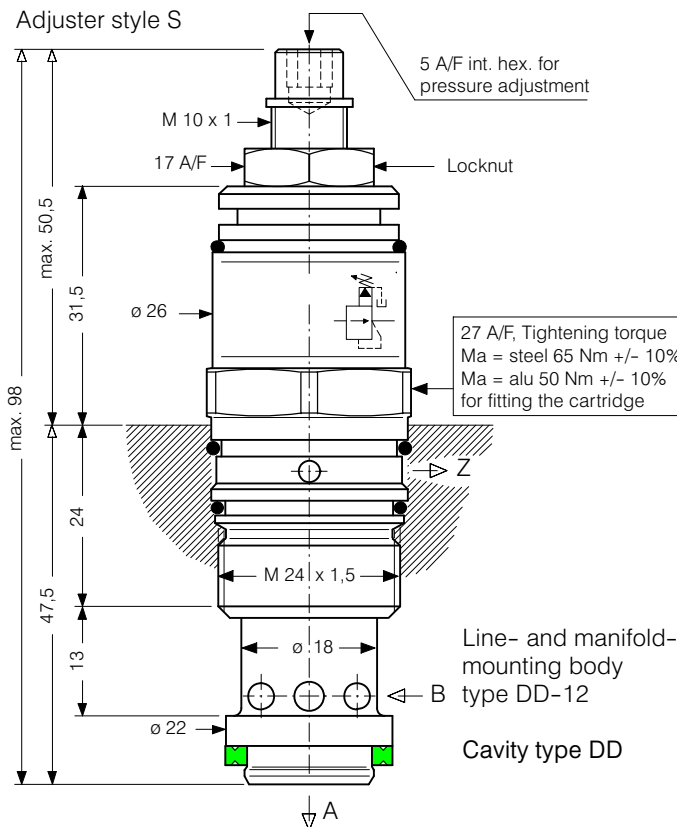

Adjuster styles / OPTIONAL

Cartridges can also be supplied with adjuster style H (see model code key)

Adjuster style H
Hand knob

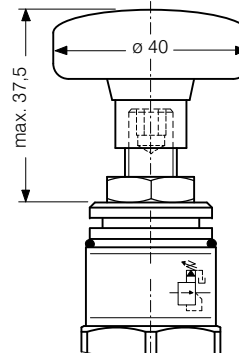

Please contact BUCHER
Adjuster style Z4
Lockable hand knob

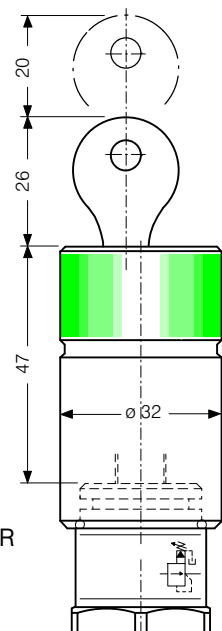

6. Schematic section

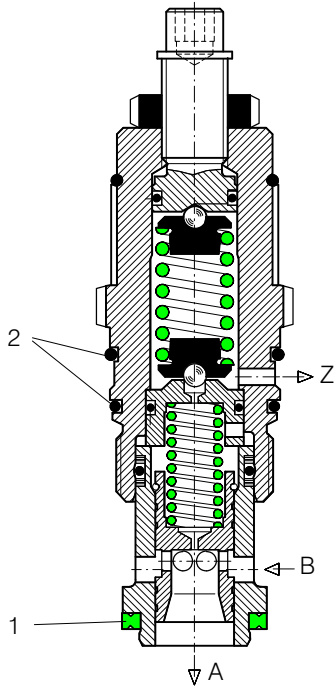

Seal kit no. DS-216-N, comprising:

Itm.	Qty.	Description	Size
1	1	Sealing ring	Ø 22,1 / 16,5 x 2,5
2	2	O-ring no. 020	Ø 21,95 x 1,78 N90

7. Installation and servicing

All installation and servicing must be carried out with care, and by qualified personnel only. Use the correct tightening torque when fitting the cartridge. When changing seals, the

new seals must be thoroughly oiled or greased before they are fitted.

8. Model code key

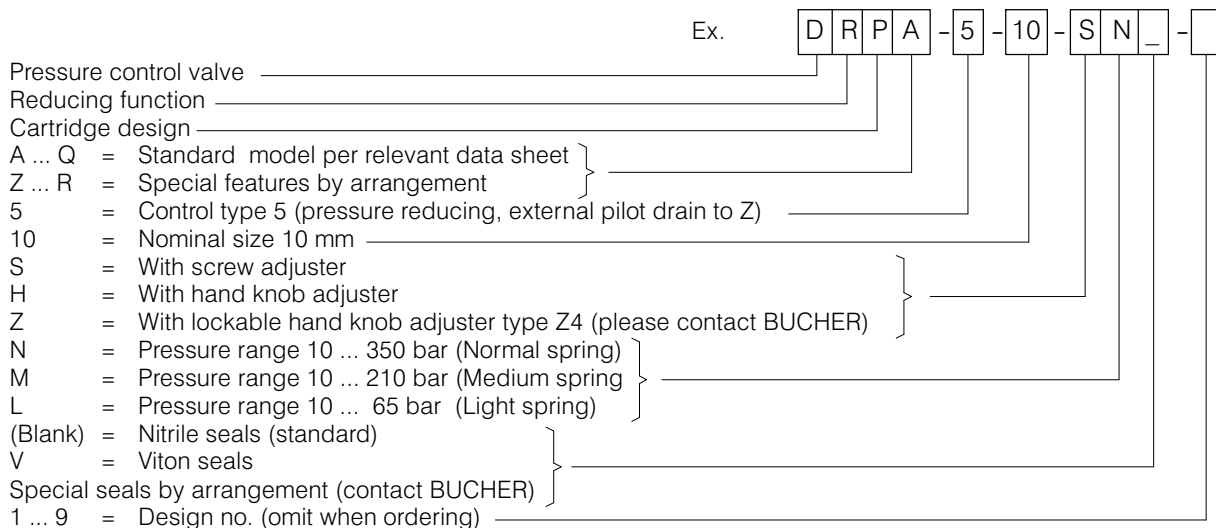

9. Related data sheets

Old no.	New no.	
G-24.21	400-P-740111-EN	BUCHER Line- and manifold-mounting body type DD-12 (G 1/2")
i-32	400-P-040011-EN	The Form tool hire programme
i-45.2	400-P-060121-EN	BUCHER cavity type DD

info.ch@bucherhydraulics.com

www.bucherhydraulics.com

© 2016 by Bucher Hydraulics AG Frutigen, CH-3714 Frutigen

All rights reserved.

Data is provided for the purpose of product description only, and must not be construed as warranted characteristics in the legal sense. The information does not relieve users from the duty of conducting their own evaluations and tests. Because the products are subject to continual improvement, we reserve the right to amend the product specifications contained in this catalogue.

Classification: 450305.305.320.355