



PRESSOSTATI

IPNB

PISTON PRESSURE SWITCH

PISTON OPERATED, FIXED DIFFERENTIAL, ELECTRO-HYDRAULIC PRESSURE SWITCH EQUIPPED WITH ELECTRIC CONTACT IN EXCHANGE.

WHEN PRE-SET PRESSURE IS ACHIEVED, THE PISTON ACTUATES A MICROSWITCH.

THE SETTING ADJUSTMENT IS REACHED BY MEANS OF A SCALED HANDWHEEL.

THE PRESSURE SWITCHES TYPE IPNB CAN BE MOUNTED IN ANY POSITION.



TECHNICAL DATA

TYPE	IPNB-035	IPNB-350
SETTING RANGE (BAR)	6 - 35 BAR	30 - 350 BAR
MAX. WORKING PRESSURE (BAR)	350 BAR	650 BAR
ACCURACY	< ± 1% OF SETTING	
FLUID TEMPERATURE (°C)	-20 - 75	
FILTRATION ACCURACY (µM)	25	
WEIGHT (KG)	0.65	

ELECTRICAL DATA

VOLTAGE (V)	125 AC	250 AC	30 DC	150 DC
MAX. CURRENT (RESISTIVE LOAD)	7 A	5 A	5 A	0.2 A
MAX. CURRENT (INDUCTIVE LOAD)	4 A	2 A	3 A	0.02 A
CONNECTION FREQUENCY	MAX. 120 CYCLES/MIN			
PROTECTION	IP-65			
DIRECT CURRENT WITH INDUCTIVE LOAD	IT IS SUGGESTED TO PROVIDE AN ARCING CONTACT			

SCHEMES

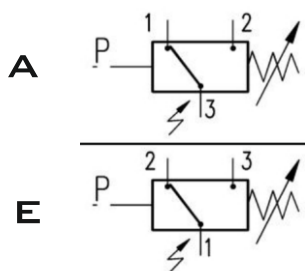

SYMBOL

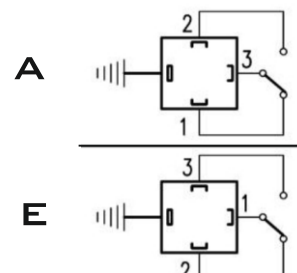

CONTACTS

CHARACTERISTIC CURVES

DIFFERENTIAL PRESSURE OF **IPNB-035**
PRESSURE SWITCH

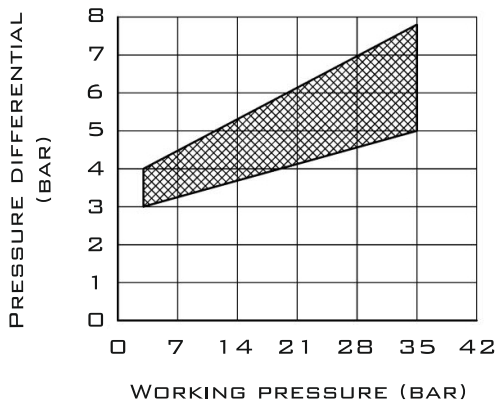

DIFFERENTIAL PRESSURE OF **IPNB-350**
PRESSURE SWITCH

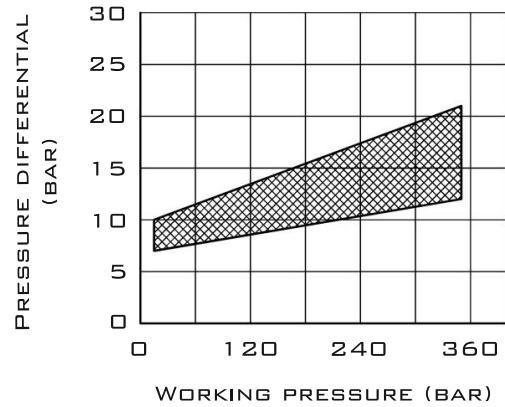

SUBPLATE INSTALLATION DIMENSIONS

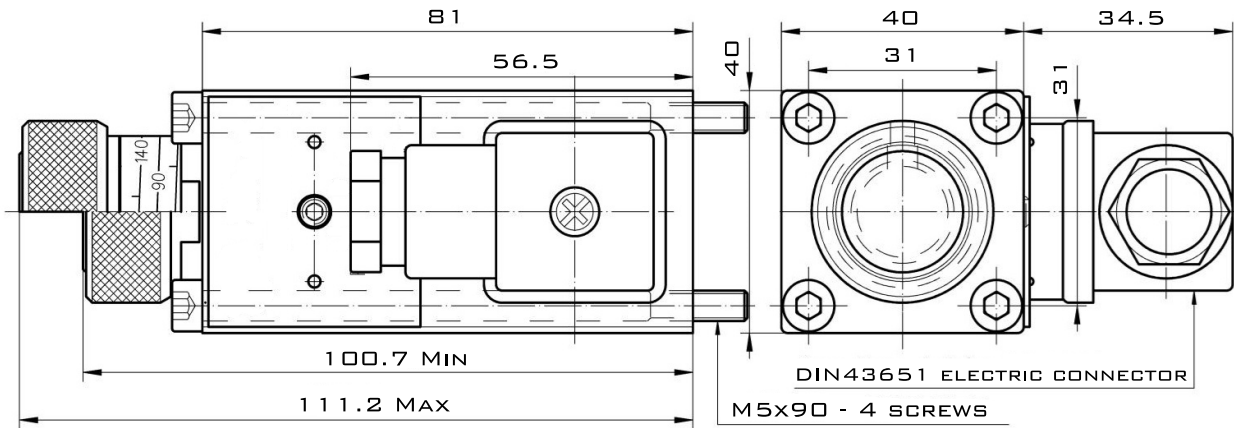

FLANGE INTERFACE

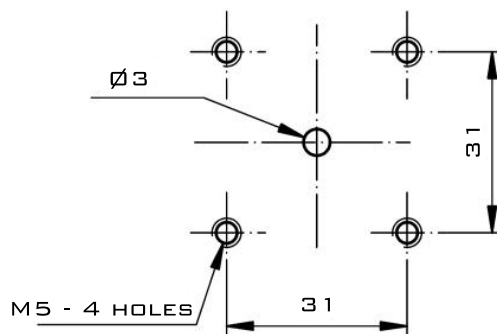



PRESSOSTATI

IPNB

PISTON PRESSURE SWITCH

ADAPTORS INSTALLATION DIMENSIONS

BMM – MALE FITTINGS

BMF – FEMALE FITTINGS

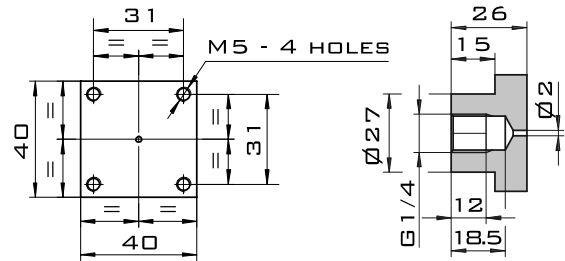
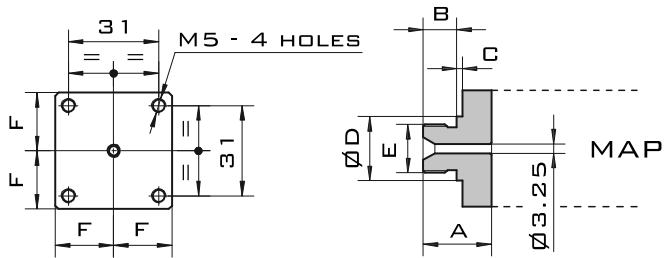

TYPE	A	B	C	$\varnothing D$	E	F
BMM-06	22.5	11	1.5	18	G1/4"	20
BMM-10	23.5	11.5	2	22	G3/8"	20
BMM-15	27.5	15	2.5	26	G1/2"	20

ORDER CODE

IPNB		
------	--	--

PRESSURE SWITCH

PRESSURE SETTING:
035=6 – 35 BAR
350=30 – 350 BAR

ELECTRIC CONTACT TYPE:
A=A TYPE
E=E TYPE