

Pressure-Reducing Valve, ISO Size 07

$Q_{\max} = 250 \text{ l/min}$, $p_{\max} = 350 \text{ bar}$
 Sandwich design, manually operated, seated pilot stage
 Series SDR...

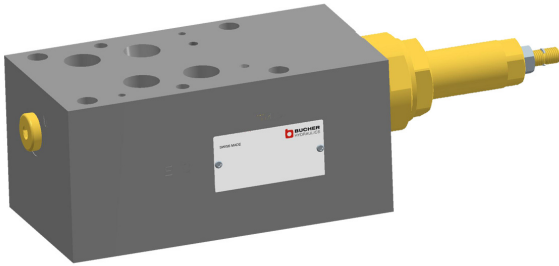

- With cartridge valve, type DRPB-5-16...
- Interface to ISO 4401-07-07
- Inline function in the P, A or B line
- Internal pilot-oil drain to port Y, A or B
- 4 pressure ranges available
- With pressure-gauge port
- Excellent stability over the whole pressure and flow range
- Responsive pressure adjustment
- Available with hand-knob or tamper-proof cap
- External cartridge parts are zinc plated and chromited (CrVI-free)
- Sandwich body is zinc-phosphated

1 Description

Series SDR... sandwich valves are high performance pressure-reducing valves with a size 07 interface to ISO 4401-07-07. The main components of the valves are a sandwich body (stack-mounting body) and the screw-in cartridge (type DRPB-5-16...). The pressure-reducing cartridges have a seated pilot stage, and the main stage is designed on the sliding-spool principle. Four pressure ranges are available for the inline function in P. Pilot oil only flows when the pilot stage is active (main stage reducing), with internal drain options to ports Y, A, or B. In this state, the secondary pressure will be maintained at a constant level as long as the primary pressure does not fall below that level. It will be maintained in the secondary side of the P line, and

also in A or B, dependent on the operating position of the directional valve. A pressure-gauge port M (G1/4") is also provided in the secondary circuit. The pressure is set by means of an adjusting screw or a hand-knob on the pilot cartridge. To safeguard pressure settings, the adjusting spindle can be sealed with a tamper-proof cap. These sandwich valves are used to reduce the system pressure in mobile and industrial applications. The sandwich body is zinc-phosphated. All external parts of the cartridge are zinc-nickel plated to DIN 50 979 and are thus suitable for use in the harshest operating environments. The sandwich body is sealed at its manifold side (the connections side) by means of O-rings fitted in counterbores.

2 Technical data

General characteristics	Description, value, unit
Designation	pressure-reducing valve
Design	sandwich design, manually operated, seated pilot stage
Mounting method	4 x $\varnothing 10.5$ holes for M10 cap screws 2 x $\varnothing 7$ holes for M6 cap screws
Size	size 07 interface to ISO 4401-07-07 / DIN 24 340 A16
Weight	8.65 kg
Mounting attitude	unrestricted
Ambient temperature range	-25 °C ... +80 °C

Hydraulic characteristics	Description, value, unit
Maximum operating pressure	- in port P - in ports A, B, Y 350 bar 250 bar
Flow range	...250 l/min
Nominal pressure ranges	...100 bar, ...160 bar, ...250 bar, ...350 bar
Flow direction	see symbol
Hydraulic fluid	HL and HLP mineral oil to DIN 51 524; for other fluids, please contact BUCHER
Hydraulic fluid temperature range	-25 °C ... +80 °C
Viscosity range	10...650 mm ² /s (cSt), recommended 15...250 mm ² /s (cSt)
Minimum fluid cleanliness Cleanliness class to ISO 4406 : 1999	class 20/18/15

3 Symbol

Function in P (inline model), with pilot-oil drain options to Y, A or B

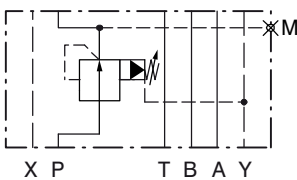

SDRA-P-16...

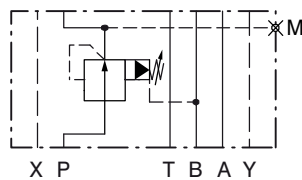

SDRA-PA-16...

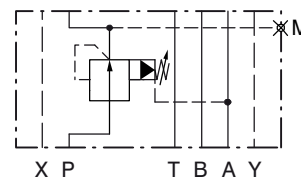

SDRA-PB-16...

4 Performance graphs



IMPORTANT!

Detailed performance data and other hydraulic characteristics can be found in the data sheet for the pressure-reducing cartridge that is fitted (data sheet ref. no. 400-P-285401-E).



ATTENTION!

The performance figures in the data sheet for the cartridge valve refer just to the cartridge itself. Take into account the additional pressure drop in the body into which it is fitted.

5 Dimensions & sectional view

With adjusting screw "S"

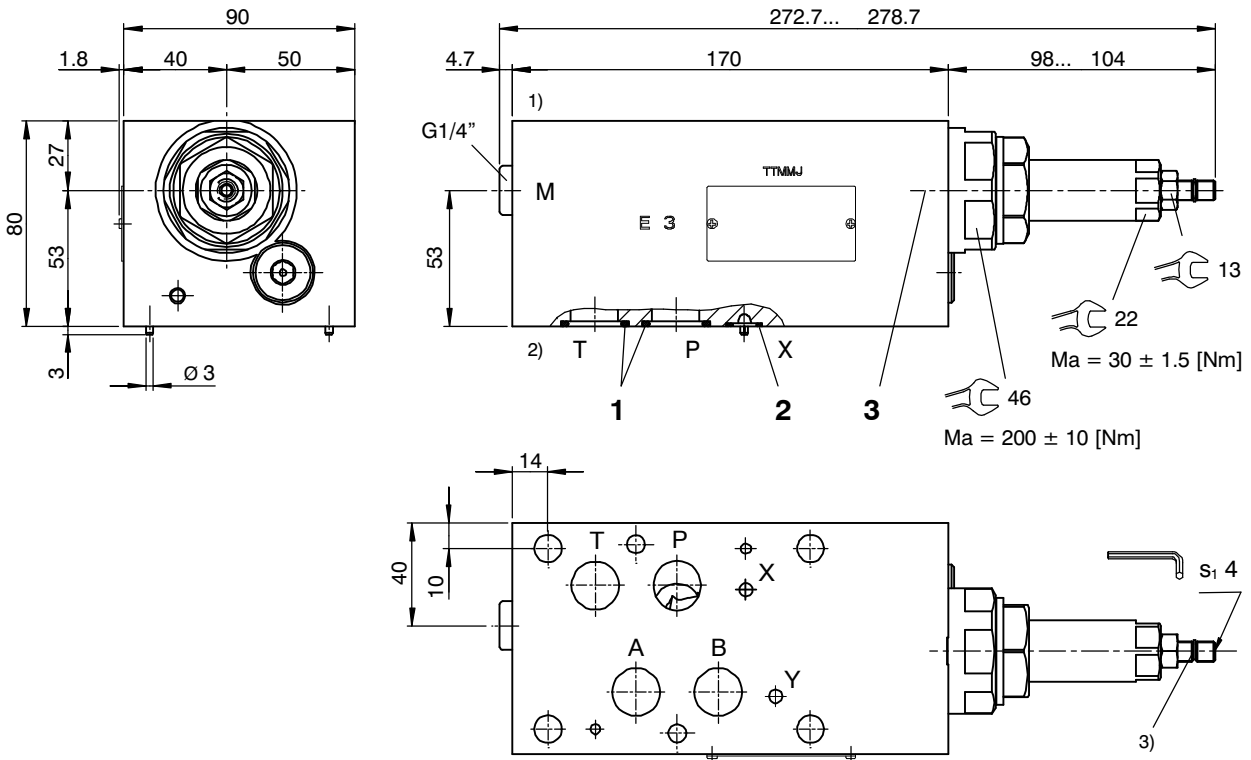

- 1) Valve side
- 2) Connections side (manifold side)

With hand-knob adjuster "H"

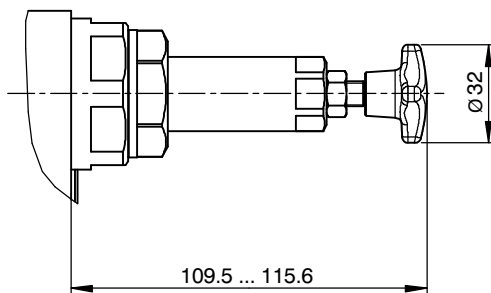

Adjusting screw with tamper-proof cap
(order separately in plain language)

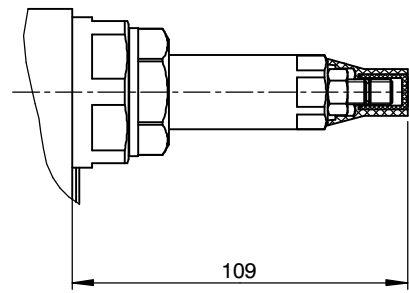

6 Installation information



IMPORTANT!

When installing the valve, make sure that the mating face (the manifold interface) aligns with the valve interface. Do not confuse the sandwich valve's manifold side and directional-valve side. Set the required pressure with the adjusting screw (s1). After you have set the valve, lock the adjusting screw with the lock nut.



ATTENTION!

Only qualified personnel with mechanical skills may carry out any maintenance work. Generally, the only work that should ever be undertaken is to check, and possibly replace, the seals. When changing seals, oil or grease the new seals thoroughly before fitting them.



IMPORTANT!

Valve settings can be sealed by fitting the tamper-proof cap. To fit the cap, the snap ring³⁾ has to be removed. Subsequent adjustment is only possible by destroying the tamper-proof cap.

NBR seal kit no. DS-319-N⁴⁾

Item	Qty.	Description
1	4	O-ring no. 118 Ø 21,89 x 2,62 N90
2	2	O-ring no. 013 Ø 10,82 x 1,78 N90
3	1	NBR seal kit no. DS-344-N for pressure-reducing cartridge DRPB-5...



IMPORTANT!

4) Seal kit with FKM (Viton) seals, no. DS-319-V

7 Ordering code

Ex. **S** **DR** **A** - **P** - **16** - **35** - **S** -

- S = sandwich design
- DV = pressure-reducing cartridge, two stage
- A ... Q = standard model - see relevant data sheets
- Z ... R = special features - please consult BUCHER
- P = Function in P, reduced pressure in P
- PA = Function in P, reduced pressure in A
- PB = Function in P, reduced pressure in B
- 16 = ISO size 07 interface
- 35 = pressure range ...350 bar
- 25 = pressure range ...250 bar
- 16 = pressure range ...160 bar
- 10 = pressure range ...100 bar
- S = screw adjuster (standard)
- H = hand-knob adjuster
- (blank) = NBR (Nitrile) seals (standard)
- V = FKM (Viton) seals
(special seals - please contact BUCHER)



IMPORTANT!

When required, the tamper-proof cap (the adjustment seal) must be ordered separately in plain language.

8 Related data sheets

Reference	(Old no.)	Description
400-P-070101	(i-51)	Size 07 interface to ISO 4401-07-07
400-P-285401	(D-5.36)	Pressure-reducing cartridge, size 16, series DRPB-5-16...
400-P-260111	(D-2.151)	Pilot pressure-relief cartridge, size 4, series DDPC-1L...

Notes

info.ch@bucherhydraulics.com

www.bucherhydraulics.com

© 2015 by Bucher Hydraulics AG Frutigen, CH-3714 Frutigen

All rights reserved.

Data is provided for the purpose of product description only, and must not be construed as warranted characteristics in the legal sense. The information does not relieve users from the duty of conducting their own evaluations and tests. Because the products are subject to continual improvement, we reserve the right to amend the product specifications contained in this catalogue.

Classification: