

D - 30.55

Stacking Hydrostat, ISO size 3

Inline Function

Direct Acting

Series SDWDPB-5D ...

23 l/min, 315 bar

- Interface to ISO 4401 / CETOP R35H size 03
NFA D03 / DIN 24 340 A6
- Hydrostat spring adjustable from 5 ... 15 bar
- With integral damping orifice in Z line
- With integral shuttle valve between A and B
- Good corrosion protection, stainless steel adjusting screw
- Option: with pressure limiting for actuator lines
- Option: with LS signal port on the mounting interface



DIMENSIONS

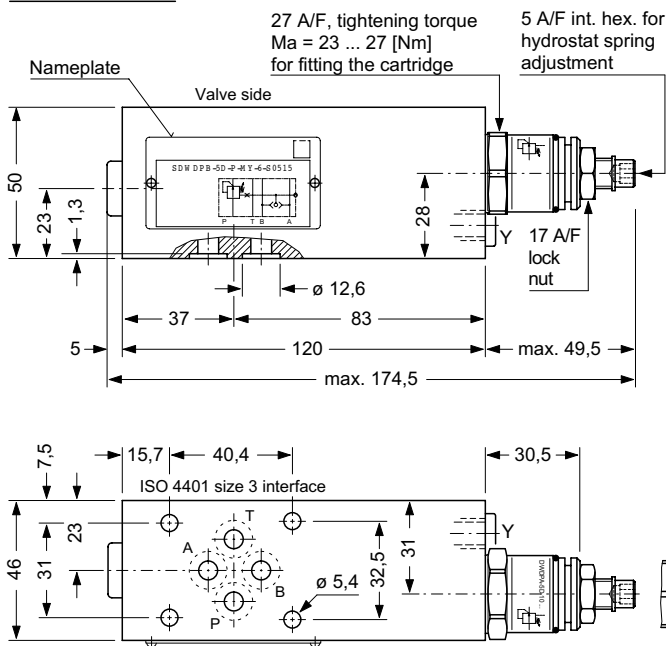

SYMBOL

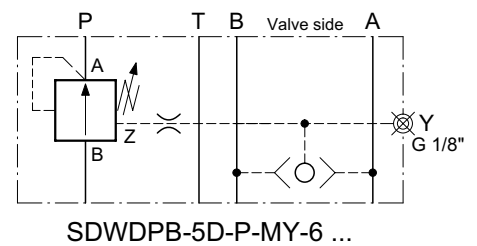

OPTIONS

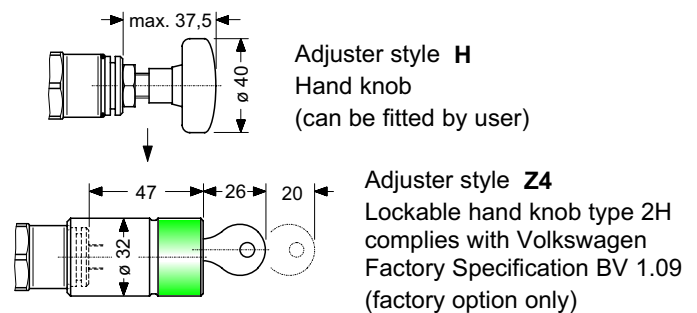

DESCRIPTION

Series SDWDPB-5D.. stack valves are applied as inline hydrostats, adjustable from 5 ... 15 bar, in hydraulic circuits. The adjustment feature permits on-site optimisation of the system without the need to replace components which have different flow ranges (e.g. proportional valves). The orifice which is essential to ensure oscillation-free operation is already incorporated in the Z port of the cartridge.

The integral shuttle valve signals the higher of the load pressures in A or B back to the hydrostat, with the result that the pressure difference across the flow control orifice remains constant.

In conjunction with an orifice or proportional valve located in the downstream P-to-A or P-to-B lines, the overall result produces the benefits of a 2-way flow control function in the P line (see the application example on page 3).

SCHEMATIC SECTION

showing the relevant ports

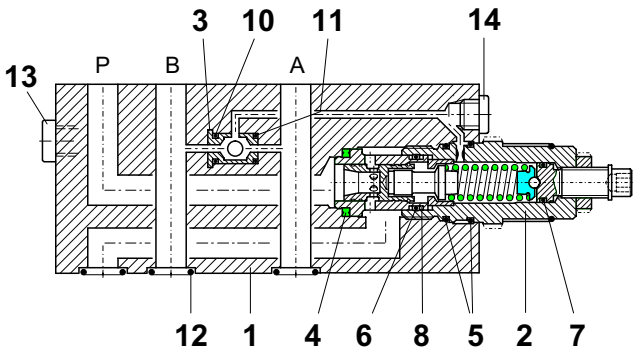

COMPONENTS / SERVICE PARTS

lt.	Qty.	Description		
1	1	Stacking body	50 x 46 x 120	type MY-06
2	1	Hydrostat cartridge	type DWDP A-5D-10 ...	
3	1	Shuttle valve	type RW-2,5	
4	1*	Seal kit no. DS-267, comprising *):		
4	1*	Seal	ø 22,1 / 16,5 x 2,5	
5	2*	O-ring no. 020	ø 21,95 x 1,78	N90
6	1*	O-ring	ø 14,00 x 2,00	N90
7	1*	O-ring no. 012	ø 9,25 x 1,78	N90
8	2*	Backup ring	ø 18 / 15,2 x 1,2	
9				
10	1*	O-ring	ø 5,50 x 1,50	N90
11	1*	O-ring	ø 4,00 x 1,50	N90
12	4*	O-ring no. 012	ø 9,25 x 1,78	N90
13	1*	Plug screw	G 1/4"	ED VSTI
14	1*	Plug screw	G 1/8"	ED VSTI

INSTALLATION AND SERVICING

MUST BE CARRIED OUT WITH CARE, AND BY QUALIFIED PERSONNEL ONLY.

At installation, be sure to mount the valve with the correct faces contacting the adjacent units and with all interface connections lining up properly.

When changing seals, the new seals should be thoroughly oiled or greased before fitting them to the valve.

Use the correct tightening torques when fitting the cartridge.

NOTE - before removing the cartridge, fully decompress the hydrostat spring by turning back the adjusting screw. If the hydrostat spring is compressed while the cartridge is removed, the cartridge neck will be pushed out of the cartridge head.

MAIN CHARACTERISTICS

Type	stacking inline hydrostat	Hydrostat spring	adjustable 5 ... 15 bar
Design	direct acting, sliding spool type	Fluids	hydraulic oils HL and HLP to DIN 51 524 other fluids - contact HTF
Mounting method	stack mounting	Min. fluid cleanliness	18/14 to ISO 4406 / CETOP RP70H 8 ... 9 to NAS 1638
Size	ISO 4401 size 03 interface nominal 6 mm	Fluid temperature range	-20° ... +60° C
Mass	1,95 kg	Viscosity range	10 ... 300 cSt
Mounting attitude	unrestricted	Flow rate Q max.	... 23 l/min
Flow direction	see symbol	Flow rate Q max. attainable at the actuator	... 23 l/min with spring $\Delta p = 15$ bar ... 10 l/min with spring $\Delta p = 5$ bar
Operating pressure	... 315 bar in P, A, B and T		

PERFORMANCE DATA Oil viscosity 33 cSt

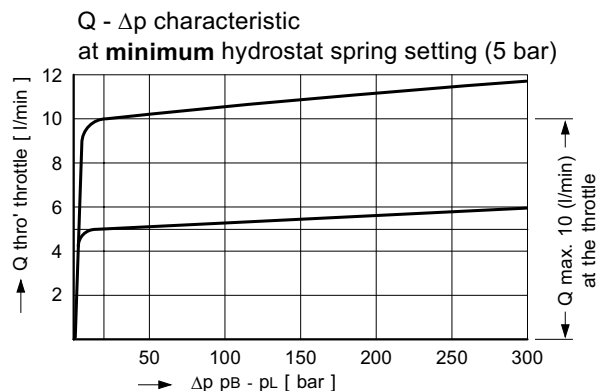
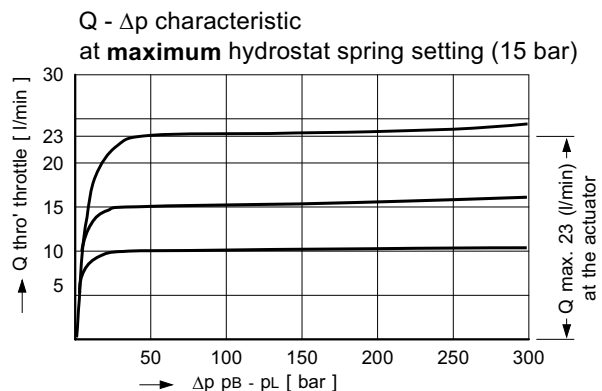

MODEL CODE KEY

Ex.

S D W D P B - 5 D - P - MY - 6 - S 0515 - 1

- S = stacking valve
- D = pressure function
- W = hydrostat
- D = direct acting
- P = with cartridge valve
- A ... Q = **standard** model per relevant data sheet
- Z ... R = special features by arrangement
- 5 = pressure control type 5
- D = with HTF cavity type DD
- P = function in P
- MY = stacking body, code MY
- 6 = ISO 4401 size 3 interface, nominal 6 mm
- S = with hex. skt. screw adjuster (**standard**)
- H = with hand knob adjuster
- Z = with lockable hand knob adjuster type Z4
- 0515 = hydrostat spring 5 ... 15 bar (stepless adjustment)
- (blank) = Nitrile seals (**standard**)
- V = Viton seals
- S = special seals by arrangement
- 1 ... 9 = design number (omit when ordering new units)

RELATED DATA SHEETS

- i - 31 DIN 24 340 A6 interface
- D - 28.55 Hydrostat cartridge, series DWDP A-5D-10 ...
- R - 32 Shuttle valve, series RW-2,5

APPLICATION EXAMPLE

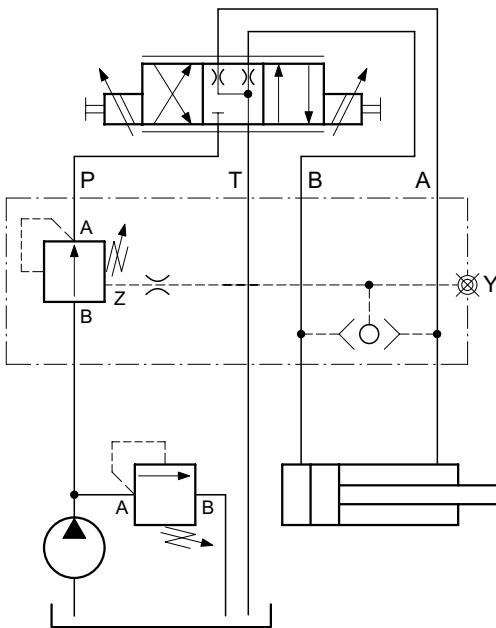

When combined with a downstream orifice, the inline hydrostat provides a two-way flow control function, with its associated benefits.

These are:

- the flow rate set by the orifice remains constant even as the load pressure fluctuates up or down

Option with pressure limiting

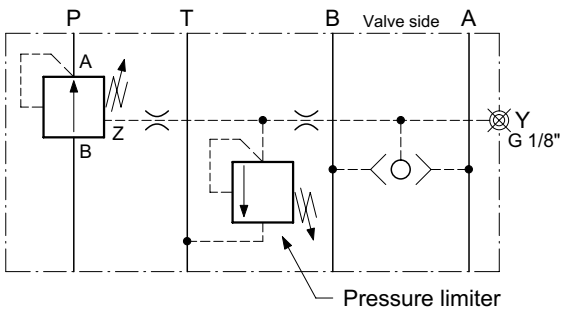

Function:

By including a pressure relief valve in the control line Z, the pressure at the outlet port A of the cartridge will be limited to the relief setting, regardless of the pressure at the inlet B. An actuator which operates at a low pressure can, in this way, be limited in the force it can produce (similar to a pressure reducing function).

Option with LS signal port

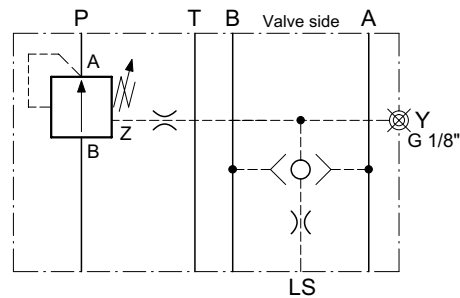

Function:

By combining several LS lines with the help of external check valves, the highest of the various load pressures in one or more stacking assemblies can be fed back to the LS pump or bypass hydrostat.