

## 2/2 Logic Cartridge Valve, Size 16 Passive Control, Seated Design, Soft Switching Series WL22SDUR ...



- 350 l/min, 420 bar
- Area ratio 2 : 1
- High flow rates with low  $\Delta p$
- Seat-valve shut-off from 1 → 2 and 2 → 1
- Glide seal on the seated valve spool
- Various opening pressures
- Orifice for pilot port is integrated in the cartridge
- all external parts are chromited and are Cr VI-free
- Can be fitted in a line-mounting body

trolled valves with the 2 switched positions "ON" and "OFF", 2 main ports 1 and 2, a pilot port 3, and a closing spring. A passive control system is integrated in the seated valve spool. Spool damping has been incorporated to provide soft-switching. All external parts are chromited (Cr VI-free) and are thus suitable for use in the harshest operating environments. For customers who manufacture their own manifold blocks, we offer form-tool sets for sale or hire. Use the GEBAA body with threaded ports (G1") for line-mounting applications.

### 1. Description

Series WL22SDUR...-16 logic cartridges are 2/2, screw-in, actively con-

### 2. Symbol

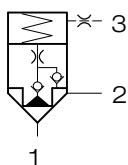

WL22SDUR ...

### 3. Main characteristics

Designation		2/2 logic cartridge valve
Design		direct acting conical-seat type
Mounting method		screw-in cartridge M42 x 2
Size		nominal size 16 mm, cavity type EB to ISO 7789-42-06-0-07
Weight	kg	1.10
Mounting attitude		unrestricted
Flow direction		1 → 2 / 2 → 1, see symbol
Operating pressure range in 1, 2 and 3	bar	... 420
Opening pressure: standard		2.0
as an option	bar	0.4 / 6 / 10 / 13
Flow rate $Q_{max}$	l/min	350
Hydraulic fluid		HL and HLP hydraulic oils to DIN 51 524; for other fluids, please consult BUCHER
Fluid temperature range	°C	-25 ... +80
Ambient temperature	°C	-25 ... +80
Viscosity range	mm <sup>2</sup> /s (cSt)	10 ... 650 recommended 15 ... 250
Minimum fluid cleanliness level		20/18/15 to ISO 4406 : 1999

## 4. Performance graphs

measured with oil viscosity 33 mm<sup>2</sup>/s (cSt)

$\Delta p$ -Q characteristics  
in cavity type EB with annular groove  
(1 → 2 and 2 → 1 with p<sub>3</sub> = 0 bar)

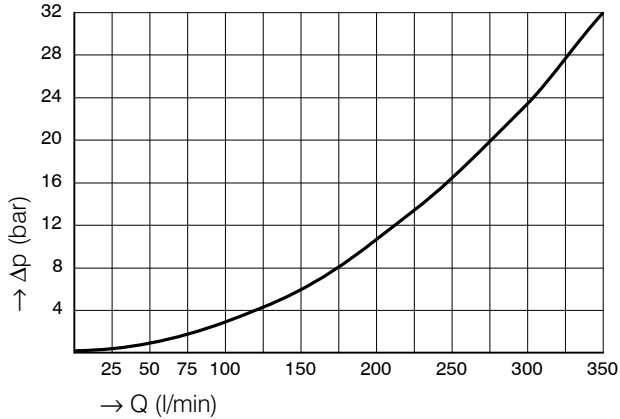

$\Delta p$ -Q characteristics  
in cavity type EB without annular groove  
(1 → 2 and 2 → 1 with p<sub>3</sub> = 0 bar)

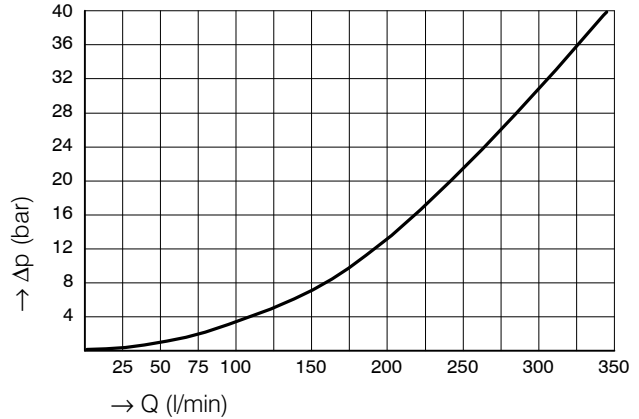

The  $\Delta p$  characteristic is valid when the load pressure in the connection 1 → 2 / 2 → 1 is greater than the opening pressure. If the load pressure is less than the opening pressure, the load pressure must first rise to overcome the opening pressure before flow can occur.

## 5. Application examples

for passively controlled logic valves

Simplified symbol

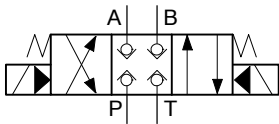

Application with 4/3 directional valve

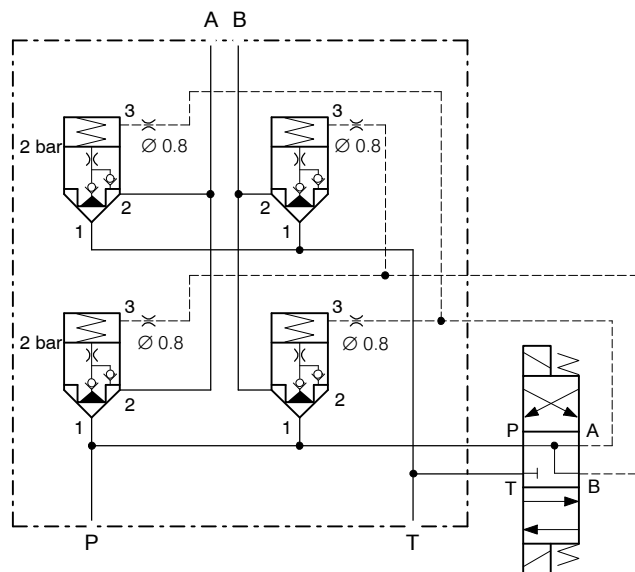

Passive control

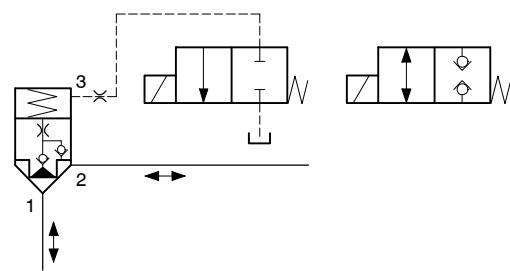

Passively controlled:

In the open condition (flow 1 → 2 / 2 → 1), there is a continuous consumption of pilot oil

## 6. Dimensions / schematic section

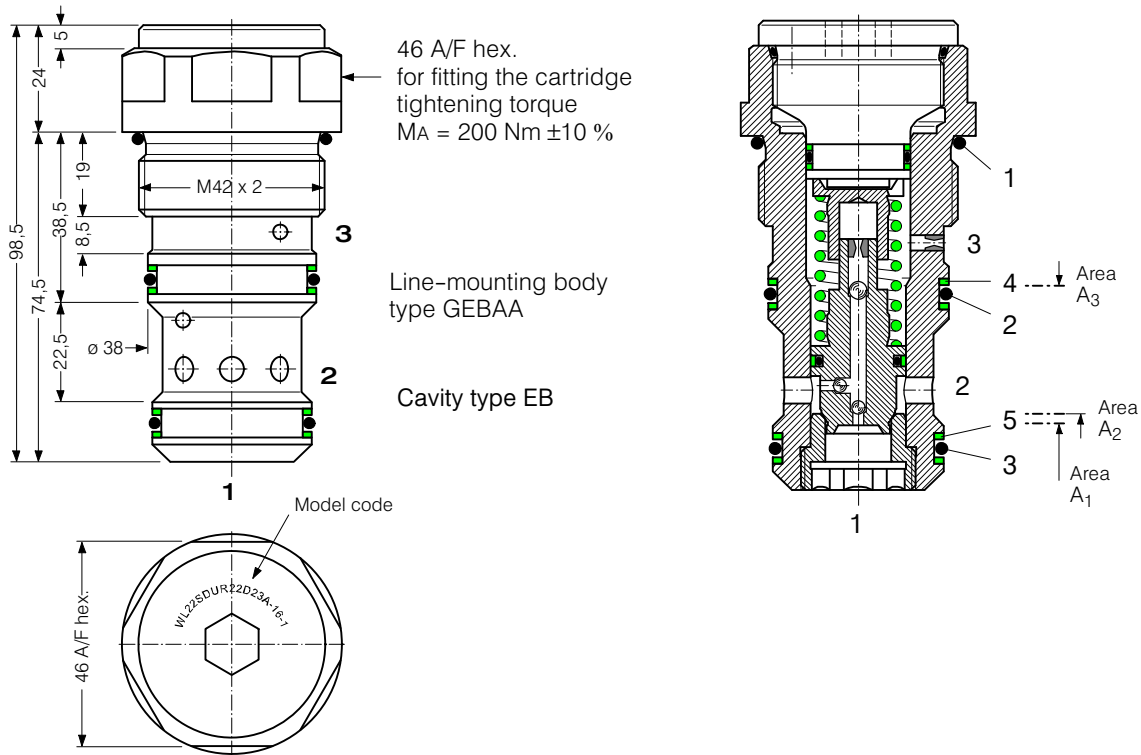

Seal kit no. DS-359, comprising:

lt.	Qty.	Description	Size
1	1	O-ring no. 129	Ø 39.34 x 2.62 N90
2	1	O-ring no. 125	Ø 32.99 x 2.62 N90
3	1	O-ring no. 124	Ø 31.42 x 2.62 N90
4	2	Backup ring	Ø 32 x 2.0 x 1.4 FI0751
5	2	Backup ring	Ø 30 x 2.0 x 1.4 FI0751

## 7. Area- and pressure-relationships

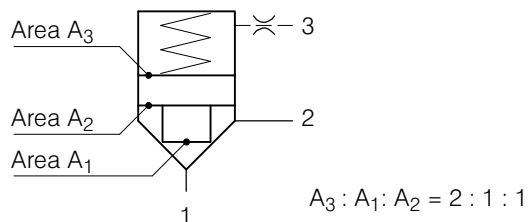

## 8. Installation and servicing

All work must be carried out with care and by qualified personnel only. When fitting the cartridge, ensure that the

seals are oiled or greased and use the specified tightening torque. When

changing seals, oil or grease the new seals thoroughly before fitting them.

## 9. Ordering code

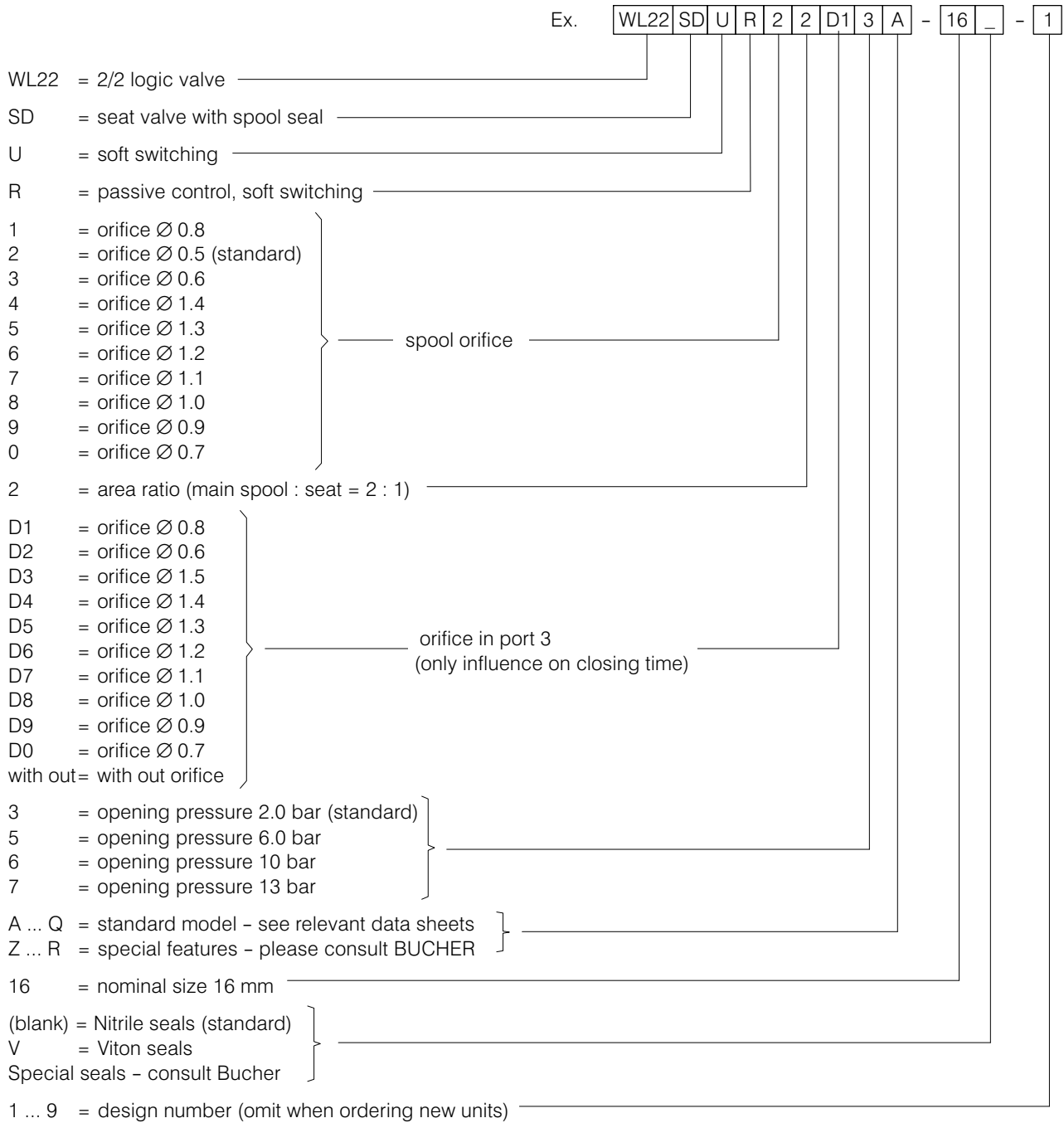

## 10. Related data sheets

Old no.	New no.	
i-32	400-P-040011-E	The form-tool hire programme
i-55.2	400-P-080111-E	Cavity type EB to ISO 7789-42-06-0-07
W-11.10	400-P-160101-E	2/2 logic cartridge valve, series WL22SD...-16
W-11.15	400-P-160121-E	2/2 logic cartridge valve, series WL22SDL...-16
G-29.22	400-P-750115-E	Line-mounting body, type GEBAA (G1")

Notes

---

[info.ch@bucherhydraulics.com](mailto:info.ch@bucherhydraulics.com)

[www.bucherhydraulics.com](http://www.bucherhydraulics.com)

© 2015 by Bucher Hydraulics AG Frutigen, CH-3714 Frutigen

All rights reserved.

Data is provided for the purpose of product description only, and must not be construed as warranted characteristics in the legal sense. The information does not relieve users from the duty of conducting their own evaluations and tests. Because the products are subject to continual improvement, we reserve the right to amend the product specifications contained in this catalogue.