

**Pressure Relief Cartridge, 10 mm
Solenoid Controlled, Two stage Spool Valve Design
for HTF Cavity Type DD
Series WUVPB-3... / WUVPZ-3 ...**

D - 6.33
Issue 08.97

10 mm nom.
p max. 315 [bar]
Q max. 120 [l/min]

- Two-pressure valve, ON / OFF or HI / LO
- WUVPB-3 ... gives very low back pressure when unloaded
- External pilot drain via port Z; secondary port can be pressurised
- Coils can be changed without opening the hydraulic envelope
- Very good price/performance ratio
- Available in line mounting body DD-12 (G 1/2")
-

DIMENSIONS

Available in wide range of ISO/CETOP 3 and 5 stacking functions

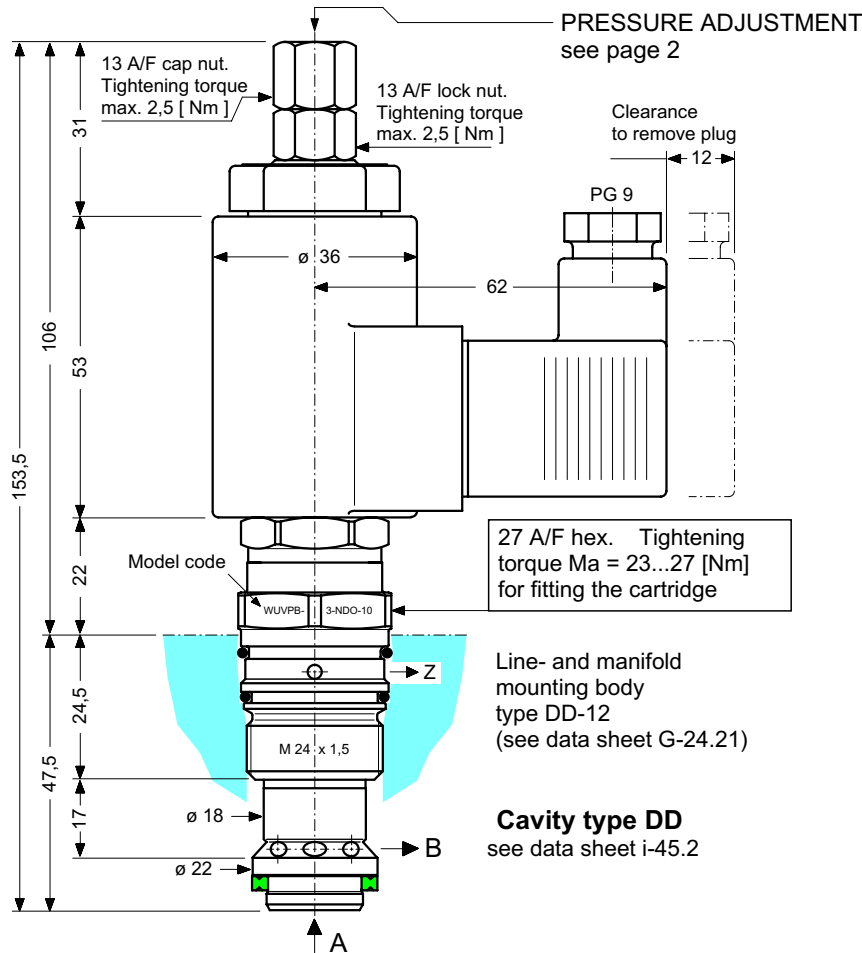

SYMBOL

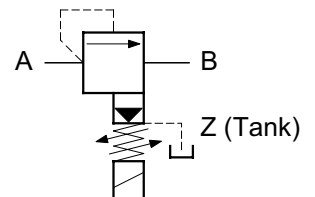

W UVPB-3.DO-10 ...
W UVPZ-3.DO-10 ...

DESCRIPTION

Series WUVPB-3 ... / WUVPZ-3 ... valves are 10 mm solenoid controlled screw-in pressure relief cartridge valves for HTF cavity type DD. They replace the WUVP-3-10 series of valves shown on data sheet D-6.4c.

They are of two-stage design, with a seated pilot stage and a sliding spool main stage.

Using only the external adjustment, a higher pressure p₁ (relief setting) and a lower pressure p₂ (a second relief setting or, alternatively, unload) can be adjusted smoothly and independently, and either pressure can be activated.

The **WUVPB-3 ...** is principally applied where an **unloading capability** with very low Δp is required (ON / OFF). The low Δp value results in less heating of the oil and therefore in **lower energy costs** for the user.

The **WUVPZ-3 ...** is principally applied where **switching between two different pressures** is required (HI / LO).

When the pilot stage is active (solenoid energised = pressure relief function), pilot control oil is drained within the valve to the Z port. **Port B can therefore be put under pressure without having any effect on the valve setting.**

Form tools are available for sale or hire, should customers wish to manufacture their own blocks or subplates.

For direct pipe-mounted applications, the line- and manifold mounting body type DD-12 (G 1/2") can be used.

D1Z-1778 / D1Z-1781
SUBJECT TO CHANGE WITHOUT NOTICE

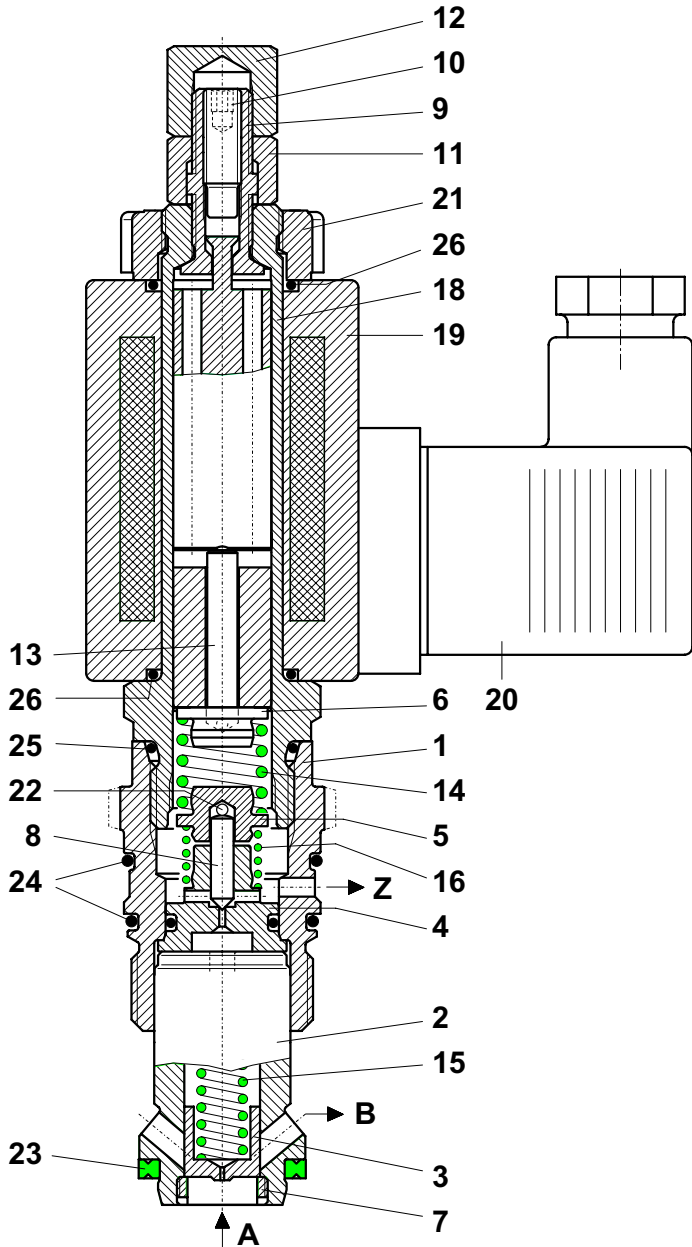

It.	Qty	Description	
1	1	Cartridge head	∅ 30 x 38,3
2	1	Cartridge neck	∅ 21,9 x 33,5
	--	Cartridge neck	∅ 21,9 x 30,5
3	1	Spool	∅ 10 x 9,8
	--	Spool	∅ 12 x 17,4
4	1	Valve seat complete	∅ 17 x 14
5	1	Spring cap	∅ 12 x 7,2
6	1	Spring cap	∅ 12 x 6,8
7	1	Threaded ring	M12 x 0,75 x3,5
8	1	Valve cone	∅ 2,99 x 12,18
9	1	Adjusting screw	∅ 11 x 24,5
10	1	Adjusting screw	M5 x 0,5 x 19
11	1	Lock nut	13 A/F x 9
12	1	Cap nut, special	13 A/F x 12
13	1	Push pin	∅ 4 x 24,2
14	1	Spring	2,00 x 12,0 x 12,0 iG = 4,5
15	1	Spring	0,90 x 6,5 x 24,5 iG = 13
	--	Spring	1,20 x 8,5 x 28,9 iG = 13
16	1	Spring	0,63 x 9,26 x 14,0 iG = 5,5
17			
18	1	Core tube S25	∅ 26 x 82,5
19	1	Coil	∅ 36 ..VAC / 25 W
	1	Coil	∅ 36 ..VDC / 27 W
20	1	Square plug, DIN 43 650, with flat seal	
21	1	Hand nut	∅ 30 x 9,2
22	2	Ball	∅ 3 DIN 5401
	1	Seal kit no. DS-261, comprising *):	
23	1*	Seal	∅ 22,1 / 16,5 x 2,5
24	2*	O-Ring no. 020	∅ 21,95 x 1,78 N90
25	1*	O-Ring no. 017	∅ 17,17 x 1,78 N90
26	2*	O-Ring no. 016	∅ 15,60 x 1,78 N70

WUVPZ-3-10 ...
WUVPB-3-10 ...

TO ORDER SERVICE PARTS, STATE:

- complete unit model code from the nameplate, including the design number
- data sheet number, including issue date
- part item number from above list
- part description from above list
- quantity required

PRESSURE ADJUSTMENT (pressure p1 must be set first, followed by pressure p2)

Setting the **higher pressure p1** as the higher working pressure on series WUVPB .../WUVPZ ... with solenoid energised:

1. Slacken and remove cap nut item 12.
2. Slacken 13 A/F lock nut item 11 approx. 1/2 turn.
3. With pump running **and with the solenoid energised**, use the two flats (7 A/F) to turn adjusting screw item 9 until the required pressure is set in A.
4. Hold the adjusting screw item 9 using the 7 A/F flats while tightening the 13 A/F lock nut item 11.
5. Refit and tighten the cap nut item 12.

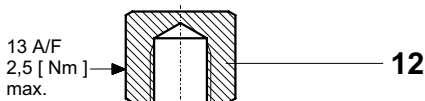

When setting pressure p1, adjusting screw item 9 must not be over-tightened as this can damage the shoulder which limits the maximum pressure setting. As soon as a definite end-stop can be felt, do not turn any further.

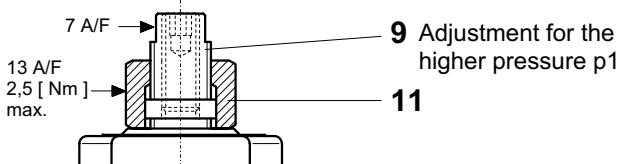

Setting the **lower pressure p2** on series WUVPZ .../WUVPB ... (a second pressure or, alternatively, unload) with solenoid deenergised:

1. Slacken and remove cap nut item 12.
2. With pump running **and with solenoid deenergised**, use the adjusting screw item 10 (2.5 A/F hex. socket) to set the pressure p2 in A.
(p2 min. - WUVPB: 2 ... 10 bar, dependent on flow)
(p2 min. - WUVPZ: 5 ... 12 bar, dependent on flow)
3. Refit and tighten the cap nut item 12.

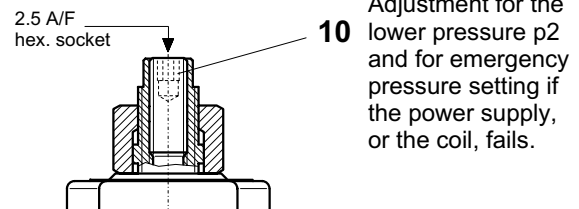
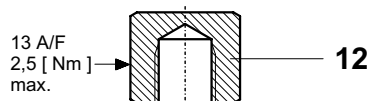

Adjustment for the lower pressure p2 and for emergency pressure setting if the power supply, or the coil, fails.

PRESSURE ADJUSTMENT (continued)

Example showing the adjustable pressures p1 and p2 (p1 ≥ p2)

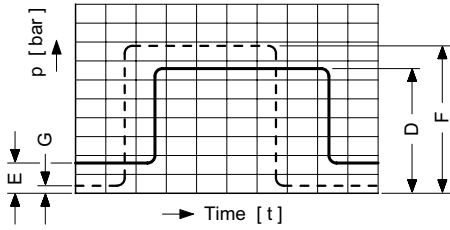

- G = adjusting screw item 10 fully unscrewed (flush with item 9)
- D, F = pressure p1, as set by item 9; solenoid energised
- E = pressure p2, min. as G, max. as D and F, as set by item 10; solenoid deenergised

— WUVPZ ... (HI / LO)

The pressure relief function is set with:
 p1 as higher working pressure (D)
 (solenoid energised)
 p2 as lower working pressure (E)
 (solenoid deenergised)

- - - - WUVPB ... (ON / OFF)

The pressure relief function is set with:
 p1 as higher working pressure (F)
 (solenoid energised)
 p2 as lowest possible unloaded pressure (G)
 i.e. item 10 unscrewed flush
 (solenoid deenergised)

INSTALLATION AND SERVICING

MUST BE CARRIED OUT WITH CARE, AND BY QUALIFIED PERSONNEL ONLY.

When changing seals, the new seals should be thoroughly oiled or greased before fitting them to the valve.

Use the correct tightening torque when fitting the cartridge.

After setting the pressures, use the correct torques when tightening the lock nut item 11 and cap nut item 12.

MAIN CHARACTERISTICS

Type	Pressure relief cartridge														
Design	with two electrically selected pressures two-stage, seated pilot, spool-type main stage with external pilot drain, solenoid controlled														
Mounting method	screw-in cartridge (M 24 x 1,5)														
Size	nominal 10 mm, HTF cavity type DD														
Mass	0,52 kg														
Mounting attitude	unrestricted														
Flow direction	A → B (see symbol)														
Operating pressure	... 315 bar in A and B														
Back pressure	max. 20 bar in Z (Tank)														
Pressure adjust. range, p1	<table border="0"> <tr> <td>pressure range N :</td> <td>20 ... 315 bar</td> <td rowspan="3">} WUVPB-3 ...</td> </tr> <tr> <td>pressure range M :</td> <td>20 ... 210 bar</td> </tr> <tr> <td>pressure range L :</td> <td>20 ... 65 bar</td> </tr> <tr> <td>pressure range N :</td> <td>10 ... 315 bar</td> <td rowspan="3">} WUVPZ-3 ...</td> </tr> <tr> <td>pressure range M :</td> <td>10 ... 210 bar</td> </tr> <tr> <td>pressure range L :</td> <td>10 ... 65 bar</td> </tr> </table>	pressure range N :	20 ... 315 bar	} WUVPB-3 ...	pressure range M :	20 ... 210 bar	pressure range L :	20 ... 65 bar	pressure range N :	10 ... 315 bar	} WUVPZ-3 ...	pressure range M :	10 ... 210 bar	pressure range L :	10 ... 65 bar
pressure range N :	20 ... 315 bar	} WUVPB-3 ...													
pressure range M :	20 ... 210 bar														
pressure range L :	20 ... 65 bar														
pressure range N :	10 ... 315 bar	} WUVPZ-3 ...													
pressure range M :	10 ... 210 bar														
pressure range L :	10 ... 65 bar														
Unloaded pressure, p2	see performance data														
Fluids	hydraulic oils HL and HLP to DIN 51 524 other fluids - contact HTF														
Min. fluid cleanliness	18/14 to ISO 4406 / CETOP RP70H 8 ... 9 to NAS 1638														
Fluid temperature range	-20° ... +60° C														
Viscosity range	10 ... 300 cSt														
Flow rate Q max.	5 ... 120 l/min (see performance data)														
Standard voltages	115 VAC, 230 VAC 50 ... 60 Hz 12 VDC, 24 VDC														
Permissible voltage fluctuation	± 10%														
Power consumption	VAC = 25 W / VDC = 27 W														
Duty cycle	100% ED														
Protection class	IP 65 to DIN 40050														
Electrical connector	3-pin square plug to DIN 43 650 / ISO 4400 other connectors - contact HTF														

D-6.33

SUBJECT TO CHANGE WITHOUT NOTICE

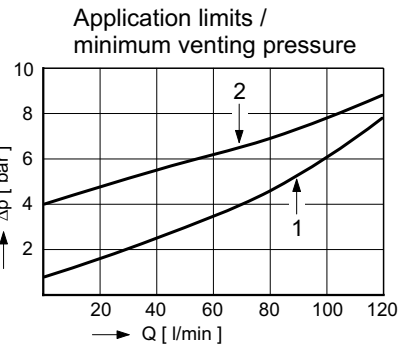
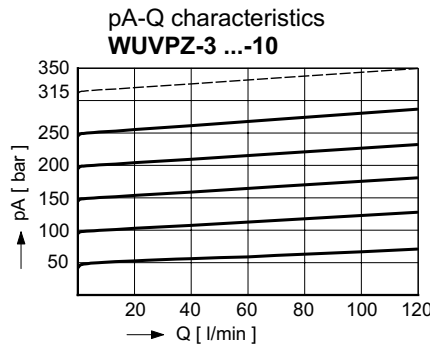
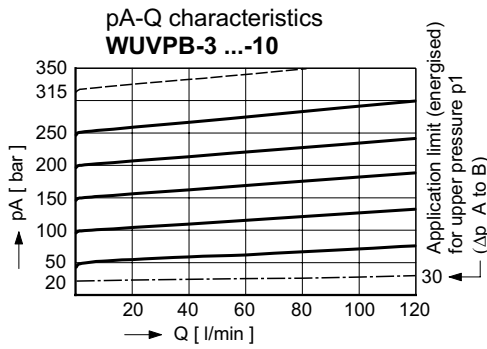

1 = WUVPB ... vented pressure (deenergised) (Δp A to B)
 2 = WUVPZ ... " " " (application limit)

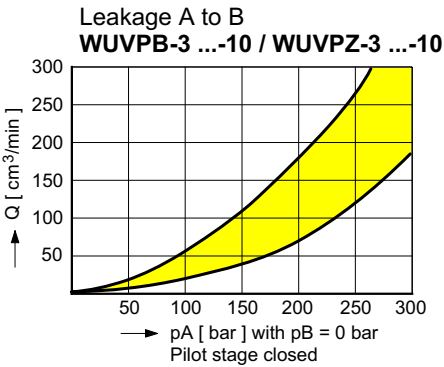

Pilot oil drain flow in Z

WUVPB-3 ...-10	250 ... 600 cm ³ /min
WUVPZ-3 ...-10	250 ... 600 cm ³ /min

Switching times: measured with 24 VDC coil, 10% under-voltage and coil at steady-state temperature

	ON	OFF
WUVPB-3 ...-10	120 ... 500 ms	≤ 20 ms
WUVPZ-3 ...-10	25 ... 70 ms	≤ 20 ms

Switching times are influenced by flow rate, pressure, supply voltage, coil temperature and oil viscosity

MODEL CODE KEY

- Solenoid controlled pressure relief valve
- Two-stage
- Cartridge design
- B** = standard model for unloading duty (ON/OFF)
- Z** = standard model for two-pressure duty (HI/LO)
- C ... Q = standard model per relevant data sheet
- Y ... R = special features by arrangement
- 3 = pressure control type 3 (with pilot drain to Z)
- N = pressure range ... 315 bar (Normal spring)
- M = pressure range ... 210 bar (Medium spring)
- L = pressure range ... 65 bar (Light spring)
- D = for HTF cavity type DD
- O = deenergised open
- 10 = nominal size 10 mm
- (blank) = Nitrile seals (standard)
- V = Viton seals
- Special seals by arrangement
- 1 ... 9 = design number (omit when ordering new units)
- Voltage and current plainly specified

Ex. W U V P B - 3 N D O - 10 - 1 24 VDC

Related data sheets

- i-45.2 HTF cavity type DD
- G-24.21 Line- and manifold mounting body DD-12 (G 1/2")

D-6.33

SUBJECT TO CHANGE WITHOUT NOTICE