

Electrically Operated Pressure-Relief Cartridge, Size 16 Seated Pilot Stage, Spool-Type Main Stage Series WUVPA-3 ...

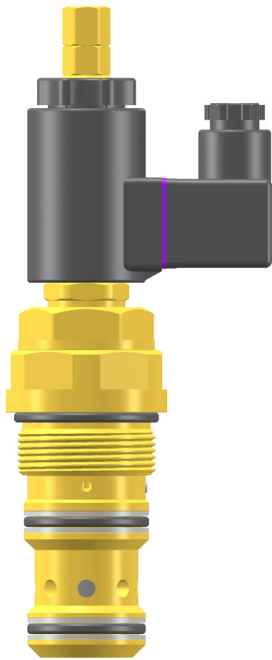

- 350 l/min, 420 bar
- Two-pressure valve, ON / OFF or HI / LO
- External pilot drain to port 3, so the secondary side can be pressurised
- Surface protection: Cartridge is chromited, Cr VI-free
- Very stable operation
- Coil can be changed without opening the hydraulic envelope
- Coils with DIN, Deutsch, Kostal or Junior Timer plug connections can be supplied
- Can be fitted in a line-mounting body

the external pressure adjustment, the higher pressure p1 (relief setting) and the lower pressure p2 (a second relief setting, or the vented pressure) can be varied smoothly and independently of one another without opening the hydraulic envelope, and either pressure can be selected. The WUVPA-3... has an external pilot oil drain. When the pilot stage is active, pilot oil is drained externally to port 3. Port 2 can therefore be pressurised without that pressure being additive to the valve pressure setting. For customers who manufacture their own manifold blocks, we offer form-tool sets for sale or hire. Use the GEBAA body with threaded ports (G1") for line-mounting applications.

1. Description

Series WUVPA-3... cartridges are electrically operated two-stage pressure-relief valves with a seated pilot stage and a spool-type main stage. Using

2. Symbol

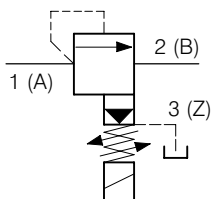

3. Main characteristics

Designation		pressure-relief cartridge for 2 electrically selectable pressures
Design		seated pilot stage, spool-type main stage with external pilot oil drain to 3
Mounting method		screw-in cartridge (M42 x 2)
Size		nominal size 16 mm, cavity type EB with annular groove to ISO 7789-42-06-0-07
Weight	kg	1.25
Mounting attitude		unrestricted
Flow direction		1 → 2 (see symbol)
Operating pressure range	bar	... 420
Back pressure in 3 (Tank)	bar	max. 20
Pressure-setting range p1	bar	pressure range 42 = 15 ... 420 pressure range 35 = 15 ... 350 pressure range 25 = 15 ... 250 pressure range 16 = 15 ... 160 pressure range 10 = 15 ... 100 pressure range 04 = 10 ... 40
Flow rate, Q _{max.}	l/min	1 ... 350, see performance graphs
Hydraulic fluid		HL and HLP hydraulic oils to DIN 51 524; for other fluids, please consult BUCHER

Fluid temperature range	°C	-25 ... +80
Ambient temperature	°C	-25 ... +50
Viscosity range	mm ² /s (cSt)	10 ... 500 recommended 15 ... 250
Minimum fluid cleanliness level		20/18/15 to ISO 4406 : 1999
Nominal voltages	VAC VDC	115, 230, (50..60 Hz) 12, 24
Nominal voltage tolerance	%	± 10
Nominal power consumption	W	VAC = 25, VDC = 27
Relative duty cycle	%	100
Protection class		IP 65 / IP 67, see "Ordering code" (when connector plugs are properly fitted)
Electrical connection		3-pin square plug to DIN EN 175301-803 (standard) for other connectors, see "Ordering code"

4. Performance graphs

measured with oil viscosity 33 mm²/s (cSt), coil at steady-state temperature and 10 % undervoltage

characteristics in cavity type EB with annular groove

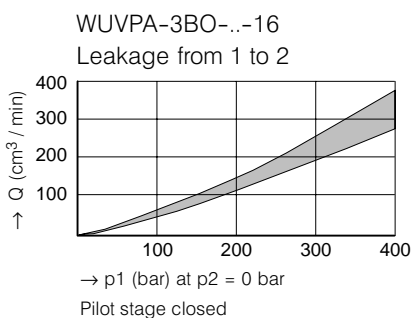
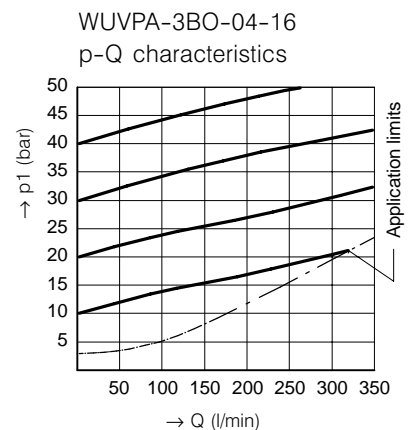
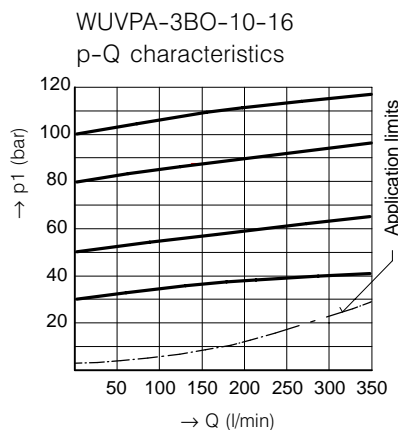
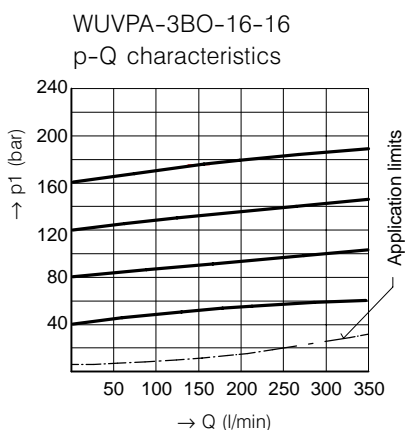
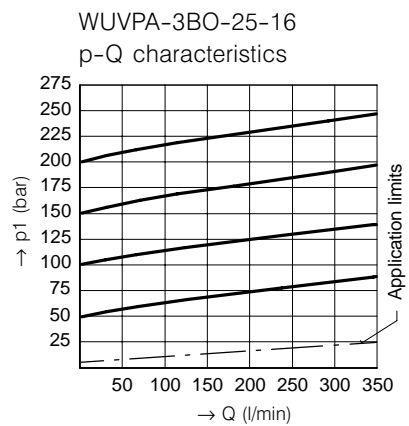
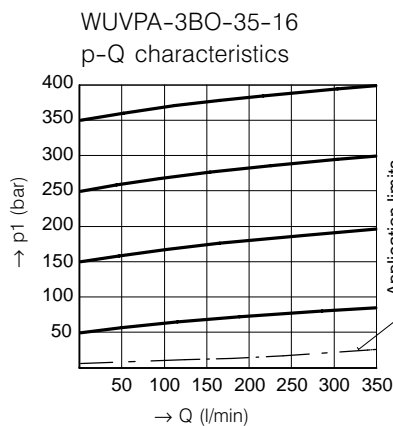
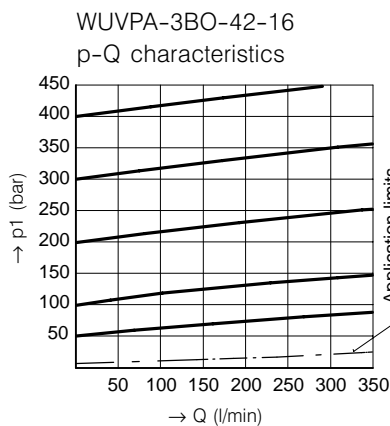

Switching times	ON	OFF
WUVPA-3...-16	50 ... 300 ms	≤ 30 ms

The switching times are influenced by flow rate, pressure, supply voltage, coil temperature, and oil viscosity.

Pilot oil consumption at 3

WUVPA-3...-16	250 ... 600 cm ³ /min

5. Setting the pressures

(pressure p1 must be set first, followed by pressure p2)

Setting the higher pressure (p1)

with pump running and solenoid energised:

1. Slacken cap nut item 12 and remove it.
2. Slacken lock nut item 11 (13 A/F) approx. 1/2 turn.
3. With pump running and solenoid energised, use the two flats (7 A/F) to turn adjusting screw item 9 until the required pressure is set in port 1.
4. Hold the adjusting screw item 9 using the 7 A/F flats while tightening the lock nut item 11 (13 A/F).
5. Refit cap nut item 12 and tighten it.

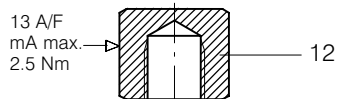

When setting pressure p1, do not over-tighten the adjusting screw item 9 as this can destroy the stop-ring that limits the maximum pressure setting. Stop turning as soon as a definite end-stop can be felt.

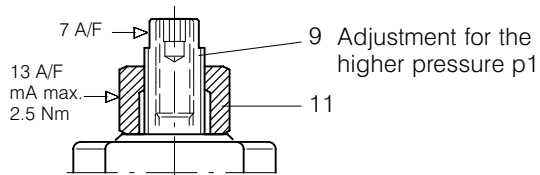

Setting the lower pressure (p2)

(second relief setting, or vented pressure) with pump running and solenoid de-energised:

1. Slacken cap nut item 12 and remove it.
2. With pump running and solenoid de-energised, use the adjusting screw item 10 (2.5 A/F hex. socket) to set the pressure p2 in port 1. (p2 min.: 2 ... 10 bar, dependent on flow rate).
3. Refit cap nut item 12 and tighten it.

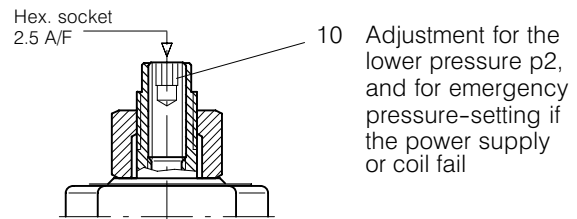
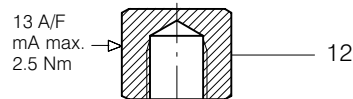

Example showing the adjustable pressures p1 and p2 (p1 ≥ p2)

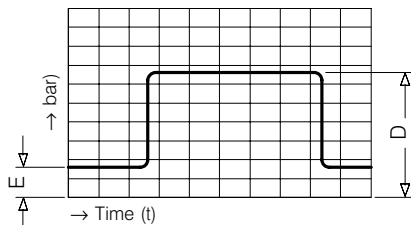

WUVPA ... (ON / OFF)

The relief pressure p1 is set as the higher working pressure (D) (solenoid energised)

p2 is set as a low vented pressure (E) (solenoid is de-energised)

D = pressure p1; as set with item 9, solenoid ON

E = pressure p2; can be set with item 10 to a maximum equal to D, solenoid OFF

6. Dimensions / Schematic section

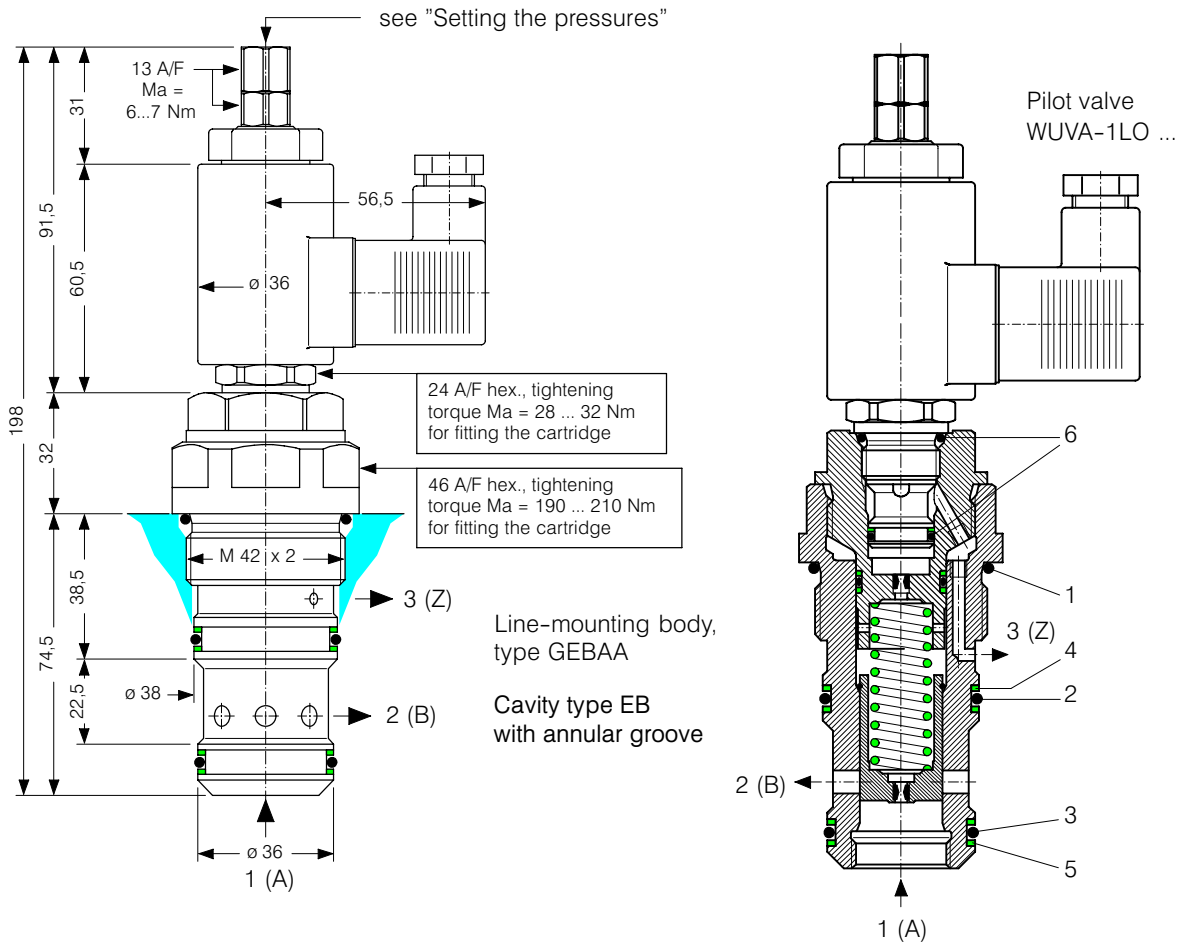

Seal kit no. DS-357, comprising:

lt.	Qty.	Description	Size
1	1	O-ring no. 129	Ø 39.34 x 2.62 N90
2	1	O-ring no. 125	Ø 32.99 x 2.62 N90
3	1	O-ring no. 124	Ø 31.42 x 2.62 N90
4	2	Backup ring	Ø 32 x 2.0 x 1.4 FI0751
5	2	Backup ring	Ø 30 x 2.0 x 1.4 FI0751
6	1	Seal kit no. DS-317 N for WUVA-1LO...	

7. Installation and servicing

All work must be carried out with care and by qualified personnel only. When fitting the cartridge, ensure that the seals are oiled or greased and use the

specified tightening torque. When changing seals, oil or grease the new seals thoroughly before fitting them.

When fitting the pilot cartridge, ensure that the seals are oiled or greased and use the specified tightening torque.

8. Ordering code

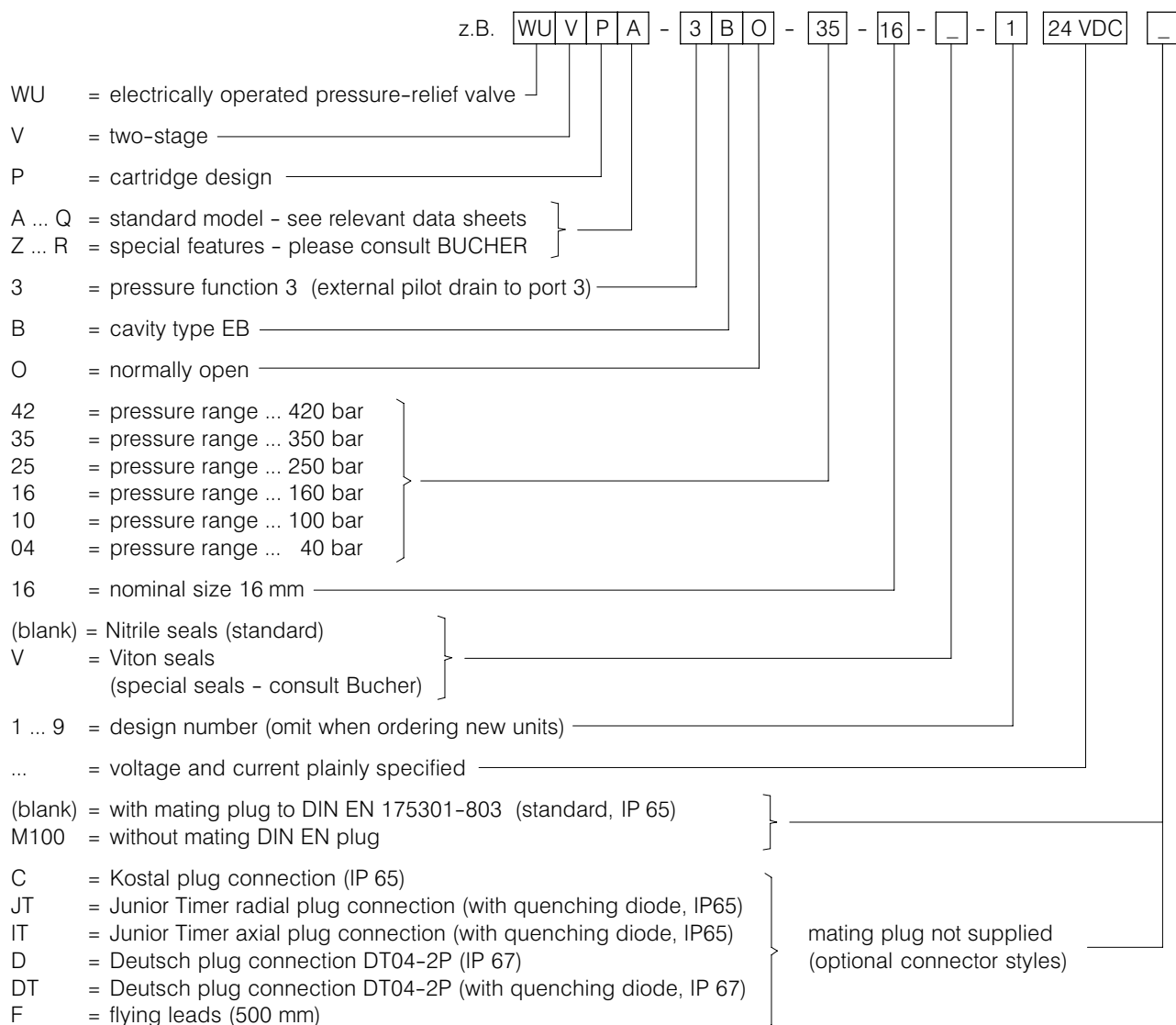

9. Related data sheets

Old no.	New no.	
i - 32	400-P-040011-E	The form-tool hire programme
i - 55.2	400-P-080111-E	Cavity type EB with annular groove to ISO 7789-42-06-0-07
W - 2.141	400-P-120110-E	Coils for screw-in cartridge valves
D - 6.10	400-P-287101-E	Pilot valve WUVA-1LO...
G - 29.22	400-P-750115-E	Line-mounting body type GEBAA (G 1")

info.ch@bucherhydraulics.com

www.bucherhydraulics.com

© 2015 by Bucher Hydraulics AG Frutigen, CH-3714 Frutigen

All rights reserved.

Data is provided for the purpose of product description only, and must not be construed as warranted characteristics in the legal sense. The information does not relieve users from the duty of conducting their own evaluations and tests. Because the products are subject to continual improvement, we reserve the right to amend the product specifications contained in this catalogue.